

INSTALLATION INSTRUCTIONS – CORDLESS ECONOMY CELLULAR SHADES

Notes:

- Save packaging until shade is installed and working to your satisfaction. Please be careful not to throw away the small clear plastic handles.
- Shades are shipped with the appropriate number of brackets and hardware
- For drywall, metal, or special cases, you may need wall anchors (not provided).
- Due to compression in shipping, the shade may initially hang slightly short. After installation, stretch the shade by running your hands over the fabric from top to bottom; the shade will stretch to desired length.

Step 1: Mount the brackets.

- Brackets can be used for **Inside Mount** (inside the window frame, secured upwards into the frame) or **Outside Mount** (secured into the wall above the window frame). Notice the label on the shade to see which you've ordered.
- For an **Inside Mount**, place each bracket $\frac{1}{4}$ " from the front edge of your window frame. Mark the placement using a pencil, using only the single hole in the top of the bracket. Secure the brackets using the screws provided.

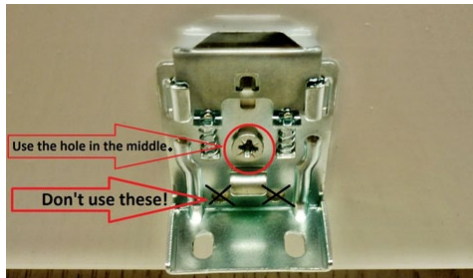

- For an **Outside Mount**, place each bracket in the desired location on the wall. Mark the placement using a pencil, using the 2 holes in the side of the bracket. Secure the brackets using the screws provided.

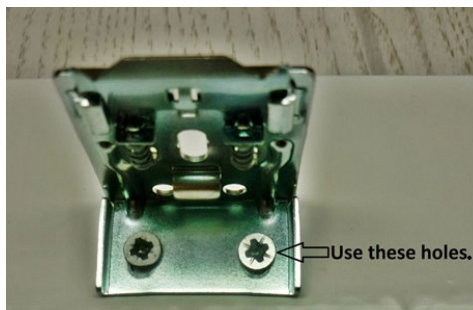

IMPORTANT: Make sure the brackets are all in line and level.

Number of brackets included with your shade:

Width	# of Brackets
0 - 38"	2
38" - 59"	3
59" +	4

Step 2: Install the shade.

- Hold the shade up near the brackets and insert the front dip of the bracket into the front groove of the rail.
- Make sure the shade is centered in the window opening.
- Push the rail back and up until the back clips of the bracket are inserted in the back groove of the rail. You will feel a snap.

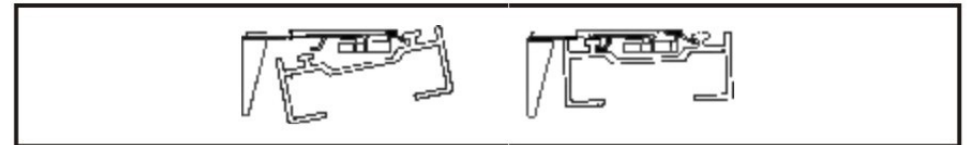

To remove the shade, reverse the procedure.

Cleaning and Care:

Regular dusting with a feather duster or vacuum cleaner brush is recommended. You can use a damp sponge and mild detergent for stains.

SETUP GUIDE

HONEYCOMB BLIND

MOTOR CM-08

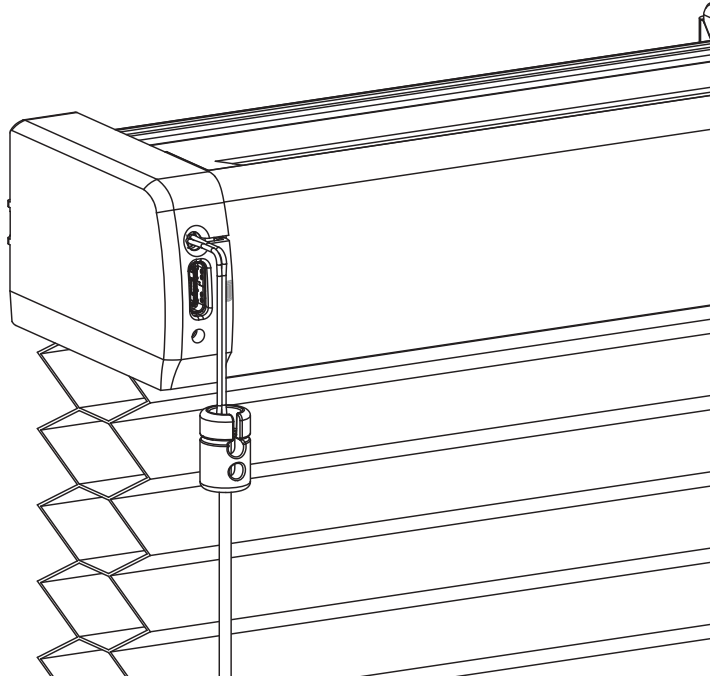

WARNING

Read the instructions carefully before assembling and using the product. Assembly can be completed by non-professionals. For indoor use only.

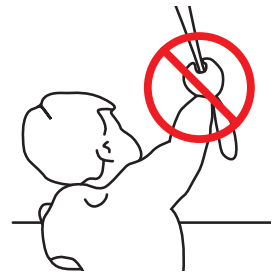

- Young children can strangle themselves with the loop of pull cords, chains and tapes, and cords that operate window coverings.
- To avoid strangulation and entanglement, keep cords out of reach of young children.
- Cords may ensnare a child's neck.
- Move beds, cots and furniture away from window covering cords.
- Do not tie cords together.
- Make sure cords do not twist together and form a loop.

2

Cleaning

Follow these general rules when cleaning the outside of the device and its components:

- Use a damp, soft, lint-free cloth. Avoid getting moisture in openings.
- Do not use aerosol sprays, solvents, alcohol, or abrasives.

Service & Support

Do not perform repairs yourself. Do not attempt to open the device or disassemble it. You run the risk of electric shock and voiding the limited warranty. No user-serviceable parts are inside.

Warranty Service

First follow the advice in this manual. If the product appears to be damaged or does not function properly, go to your local dealer for instructions on how to obtain warranty service.

Recycle

This marking indicates that this product should not be disposed with other household wastes throughout the EU. To prevent possible harm to the environment or human health from uncontrolled waste disposal, recycle it responsibly to promote the sustainable reuse of material resources. To return your used device, please use the return and collection systems or contact the retailer where the product was purchased. They can take this product for environmental safe recycling.



IP 20



Conforms to
UL Std. 325
Certified to
CSA Std. C22.2#247

Important Safety instructions

WARNING: To reduce the risk of severe injury or death, it is important to follow these instructions for personal safety. Save these instructions.

- Read and follow all installation instructions.
- This appliance can be used by children aged 8 years and above and persons with reduced physical, sensory or mental capabilities or lack of experience and knowledge if they have been given supervision or instruction concerning use of the appliance in a safe way and understand the hazards involved. Children should not play with the appliance. Cleaning and user maintenance should not be performed by children without supervision.
- Do not allow children to play with fixed controls. Keep remote controls away from children.
- Frequently examine the installation for imbalance and signs of wear or damage to cables and springs. Do not use if repair or adjustment is necessary.
- This instruction manual is also available on the website.
- The drive must be disconnected from its power source during cleaning, maintenance and when replacing parts.
- The A-weighted emission sound pressure level of the drive is equal to or less than 70dB(A).
- Indoor and household use only.
- Disconnect the drive from the power supply or switch off the automatic controls when maintenance, such as window cleaning, is being carried out in the vicinity.
- When operating a biased switch, make sure that other persons are kept away.
- Do not operate when maintenance, such as window cleaning, is being carried out in the vicinity.
- The tube motor must only be supplied with safety extra low voltage corresponding to the marking on the appliance.

Important Installation instructions

WARNING: Important safety instructions. Follow all instructions, since incorrect installation can lead to severe injury.

- This motor can only be used with soft material for driven parts.
- Hazardous unprotected moving parts of the drive must be installed higher than 2.5m above the floor or any other level surface that could provide access to it.
- Install the actuating member of a manual release at a height less than 1.8m.
- The actuating member of a biased switch is to be located within direct sight of the driven part but away from moving parts. It is to be installed at a minimum height of 1.5m and not accessible to the public.
- The mass and the dimension of the driven part must be compatible with the rated torque and rated operating time.
- Fixed controls have to be clearly visible after installation.
- The driven part must be compatible with the rated torque CM-08 0.6N.m and rated operating time (12 min).
- The drive is intended to be installed at a height of at least 2.5m above the floor or any other accessible level surface.
- All-pole disconnection switches must be incorporated in the fixed wiring in accordance with the wiring rules.
- The appliance must only be supplied at safety extra low voltage corresponding to the marking on the appliance.
- Before installing the drive, remove any unnecessary cords or components and disable any equipment not needed for powered operation.

FCC Manual

FCC ID: ZY4CMD08B

Regulatory Information

1 FCC Information for User

This product does not contain any user serviceable components and is to be used with approved antennas only. Any product changes or modifications will invalidate all applicable regulatory certifications and approvals.

2 FCC Electronic Emission Notices

This device complies with part 15 of the FCC Rules. Operation is subject to the following two conditions:

1. This device may not cause harmful interference
2. This device must accept any interference received, including interference that may cause undesired operation.

3 FCC Radio Frequency Interference statement

This equipment has been tested and found to comply with the limits for a class B digital device, pursuant to Part 15 of the FCC Rules. These limits are designed to provide reasonable protection against harmful interference when the equipment is operated in a commercial environment.

This equipment generates, uses and can radiate radio frequency energy and, if not installed and used in accordance with the instructions, may cause harmful interference to radio communications.

Operation of this equipment in a residential area may cause harmful interference, in which case the user will be required to correct the interference at their own expense. If this equipment does cause harmful interference to radio or television reception, which can be determined by turning the equipment off and on, the user is encouraged to try to correct the interference by one or more of the following measures:

- Reorient or relocate the receiving antenna
- Increase the distance separating the equipment and receiver
- Connect the equipment to an outlet on a circuit different from that to which the receiver is connected
- Consult the dealer or an experienced radio/TV technician for help

EU Declaration

Hereby, Coulisse declares that the radio equipment type CM-08 is in compliance with directive 2014/53/EU. The full text of the EU declaration of conformity is available at the following internet address: www.my.coulisse.com

- Frequency range: 433 MHz, RF power: 2.32 dBm
- Frequency range BLE: 2402 - 2480 MHz, RF power: 3 dBm EIRP

i Buttons and functions

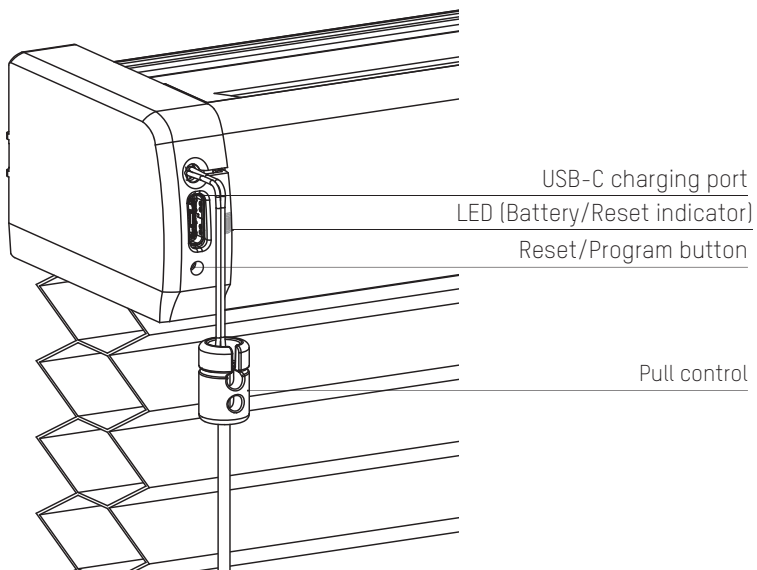

1 Install the blind

Follow the steps in the installation instructions to install the blind.

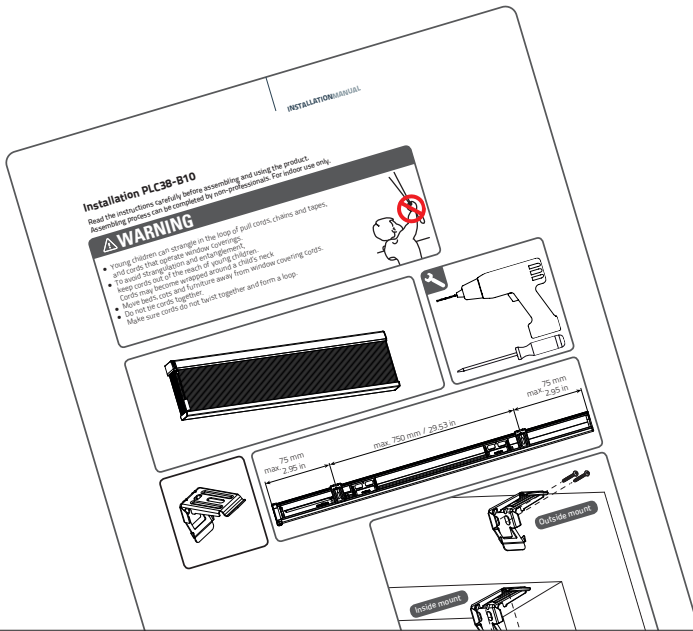

2 Activate the blind

To activate the blind, connect it to a standard USB-C 5V power supply via a USB-C cable. This can be your iPhone's power adapter, for example.

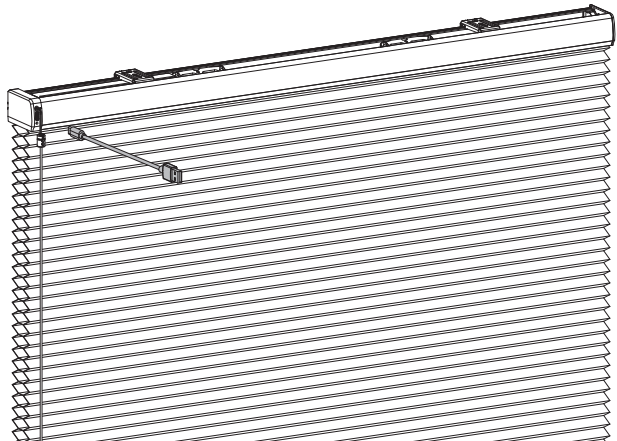
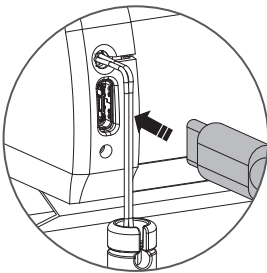

3 Download the MotionBlinds bluetooth app

Download the Motion Blinds bluetooth app from the App Store.



App Store
Download the
MotionBlinds
Bluetooth app
rtube.nl/red1614



Google Play
Download the
MotionBlinds
Bluetooth app
rtube.nl/red1615

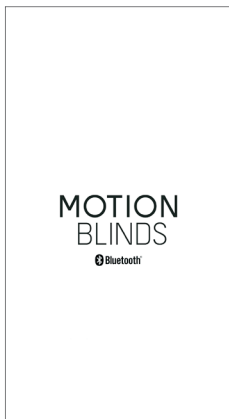

4 Setup the blind

Open the MotionBlinds bluetooth app and tap the + sign. The app will now guide you through the setup process.

The end positions of the blind, top and bottom, are pre-programmed. These can be adjusted in the app.



5 Hide the MotionBlinds Setup Code

Slide the tassel up and rotate a quarter turn to hide the MotionBlinds Setup Code into the tassel.

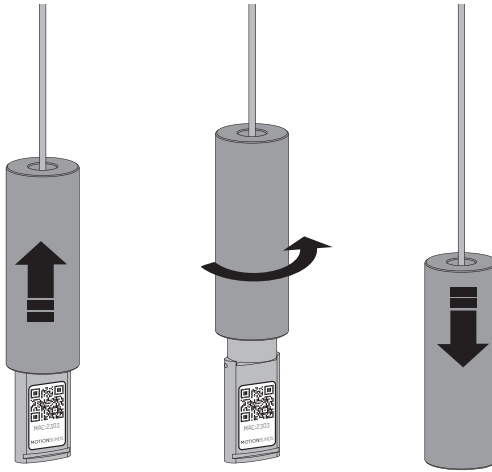

8

6 Adjustments

Change bottom positions :

If the blinds end positions are incorrect please open the settings of the blind and adjust the bottom position.

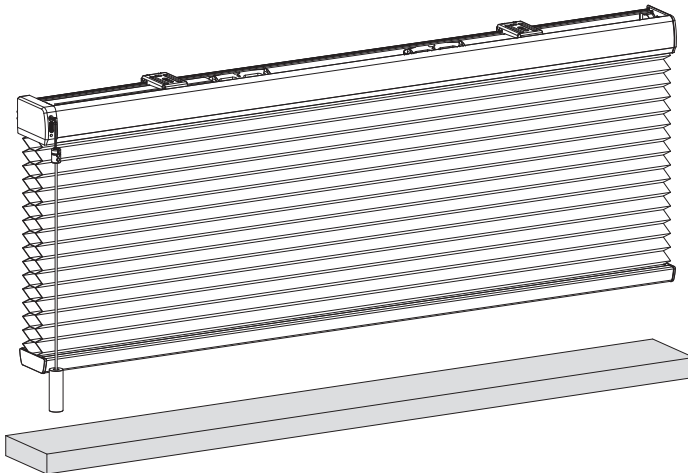

i Pair a remote control

- 1** Select a channel on the remote and press the program button on the motor to activate program mode. The blind will start stepping up and down.

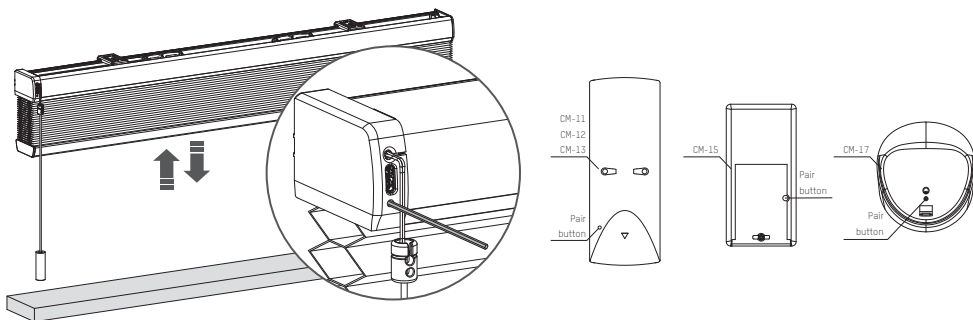

- 2** Press the pair button on the back of the remote control to pair the blind with the selected channel. The blind will shortly stop stepping, indicating that the remote has been paired to the blind.
- 3** Shortly press the program button to deactivate program mode. The blind stops stepping and can be operated.

i Pair with a bridge

With the MotionBlinds bridge you can unlock more options, such as voice assistants and the ability to control your blinds when you are not at home.



App Store
Download the
MotionBlinds
Wi-Fi app
rtube.nl/red981



Google Play
Download the
MotionBlinds
Wi-Fi app
rtube.nl/red982



i Recharge the blind

To charge the blind, connect it to a standard USB-C 5V power supply via a USB-C cable. This can be your iPhone's power adapter, for example.

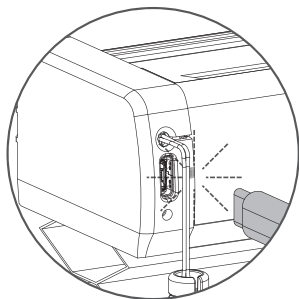

LED light flashes red during operation;
Charge the battery

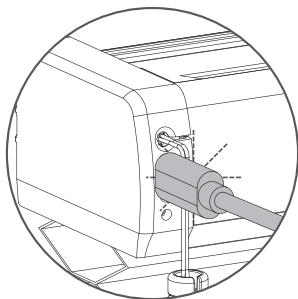

LED light flashes green;
battery is charging

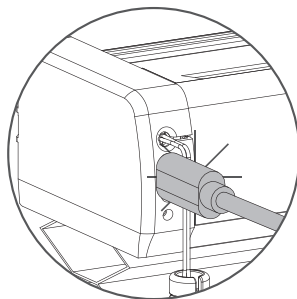

LED light constantly green;
battery is fully charged

10

i Reset the connection

Hold the program button for 10 seconds to delete the connection between the blind and the app. The LED lights up 5 times and the blind steps up and down 1 time to indicate that the connection is reset. Now the blind can be reconnected.

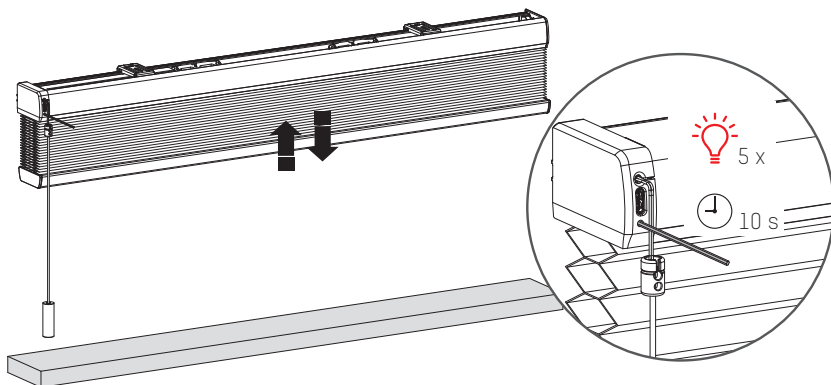

i Reset the blind

Resetting the blind results in deleting the end positions and connections of the blind with apps and remote controls. Shortly press the program button to activate program mode. The blind will start stepping up and down. Hold the reset/program button for at least 20 seconds to reset the blind. The blind will stop stepping twice. After the second stop, the blind will give one extra step to indicate that it has been reset.

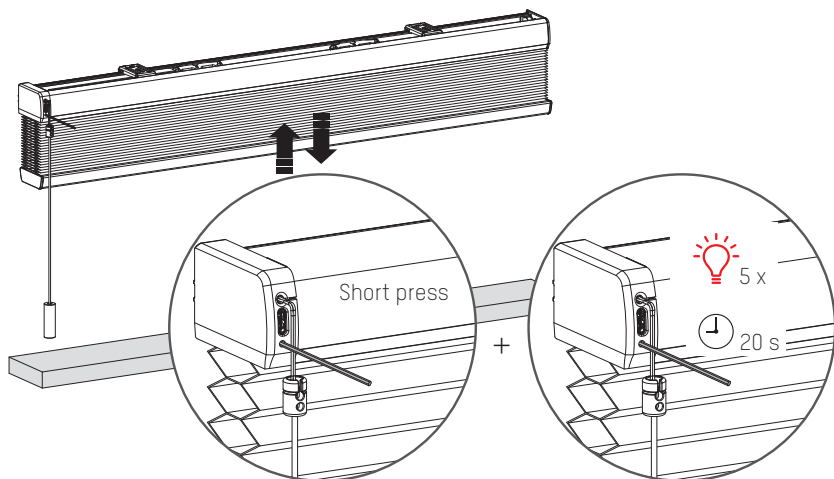

REMOTE PROGRAMMING

1 Pair a remote control

Any MOTION Blinds remote can be connected to your blind.

- 1 Select a channel on the remote and press the program button on the motor to activate program mode. The blind will start stepping up and down.

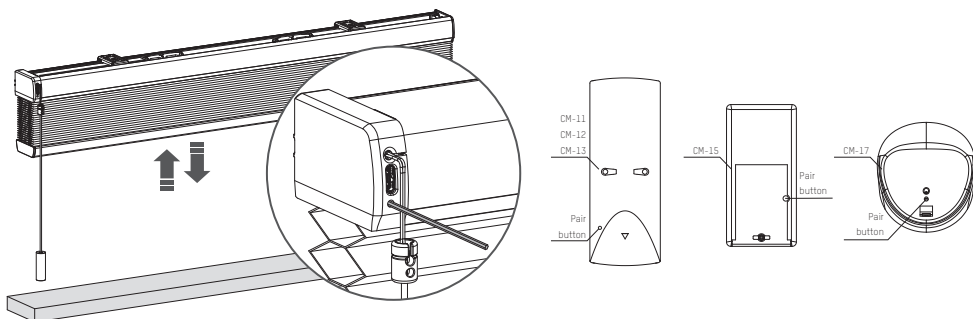

- 2 Press the pair button on the back of the remote control to pair the blind with the selected channel. The blind will shortly stop stepping, indicating that the remote has been paired to the blind.

- 3 Shortly press the program button to deactivate program mode. The blind stops stepping and can be operated.

2 Check rotational direction

! WARNING: risk of damage. Stop the blind before reaching the end positions.

- 1 Shortly press the down button to check if the blind unrolls the right way. If the blind moves up, the rotational direction must be changed.
- 2 Simultaneously press the up and down button to change the rotational direction.

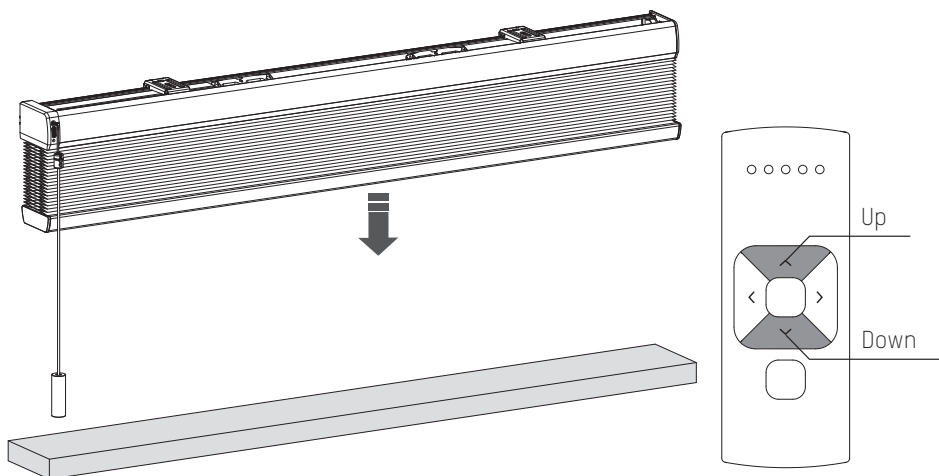

3 Set bottom position

Press and hold the down button until the blind reaches the desired bottom position. **WARNING:** risk of damage.
Slowly approach the bottom position.

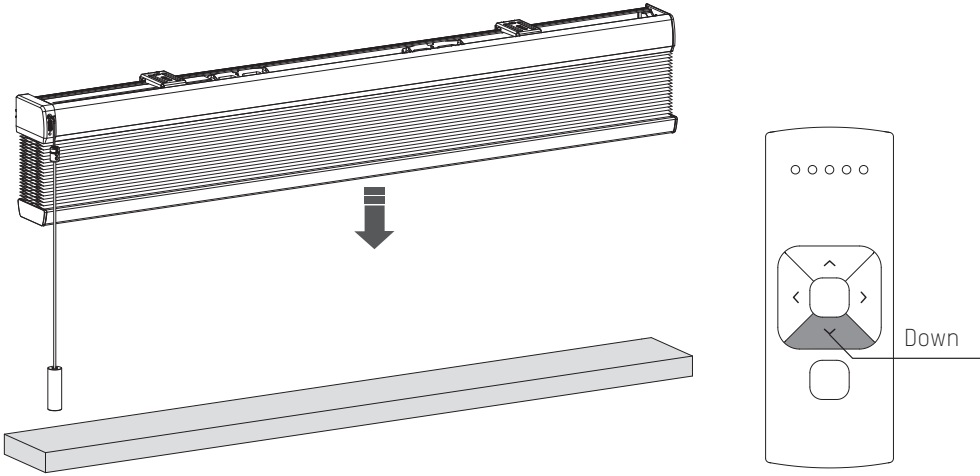

4 Save bottom position

Simultaneously hold the centre and the up button until the blind stops stepping and starts stepping again.
The bottom position has been saved.

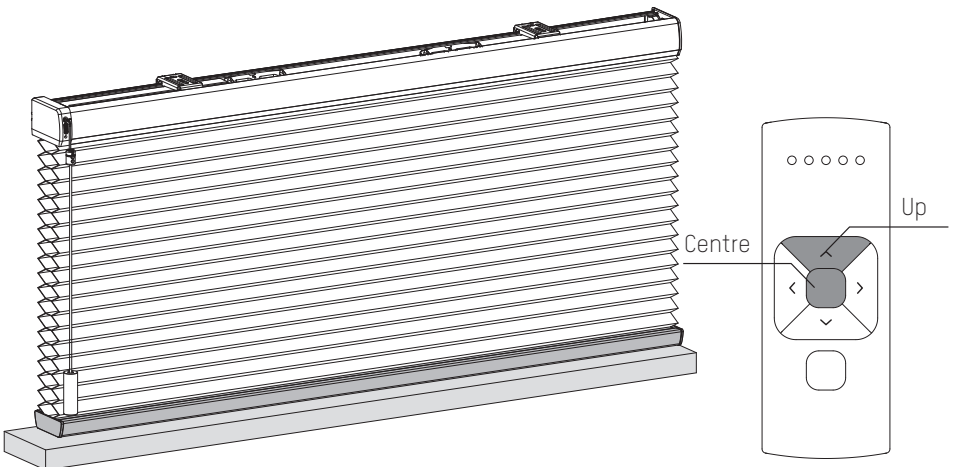

5 Set top position

Press and hold the up button until the blind reaches the desired bottom position.

WARNING: risk of damage.

Slowly approach the top position.

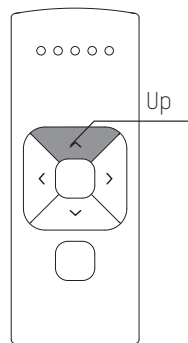
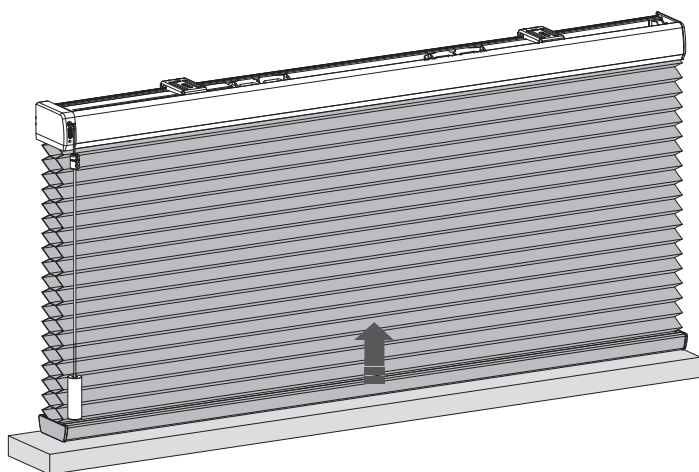

6 Save top position

Simultaneously hold the centre and the down button until the blind stops stepping and starts stepping again.

The top position has been saved.

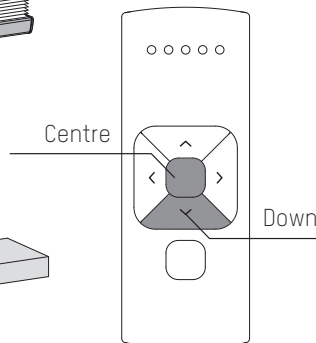
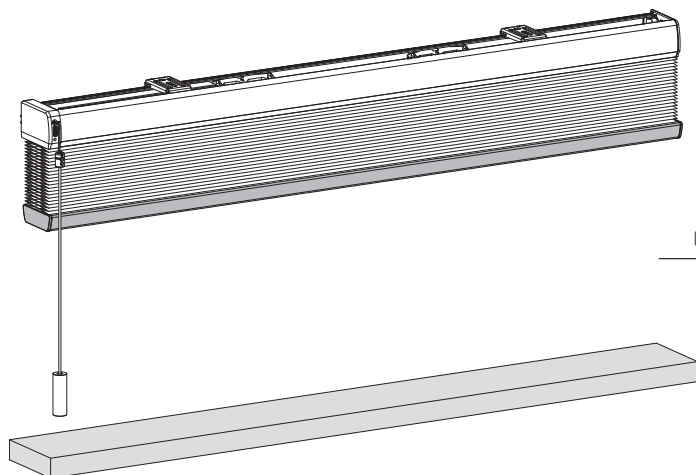

7 Set favorite position (optional)

- 1 Move the blind to a desired favourite position.
- 2 Hold the centre button to save this Favourite position. The blind shortly stops stepping indicating the favourite position has been saved.

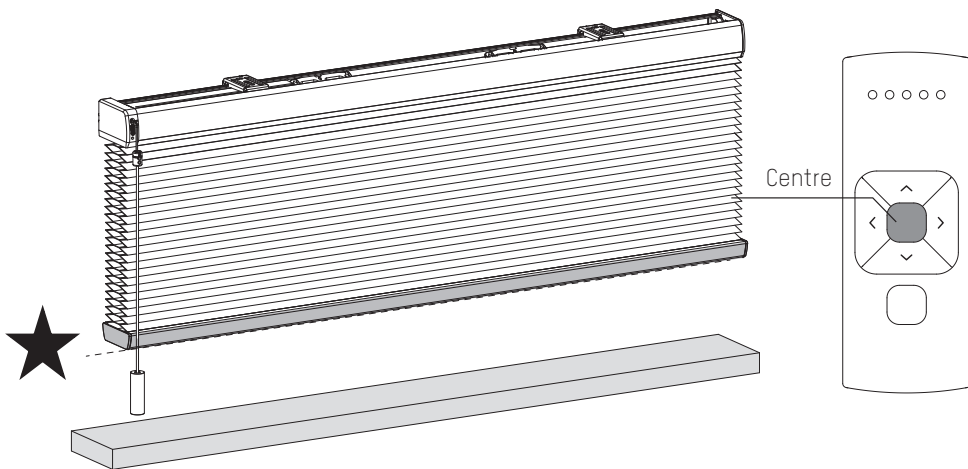

8 Deactivate program mode

Shortly press the program button to deactivate program mode. The blind stops stepping and can be operated.

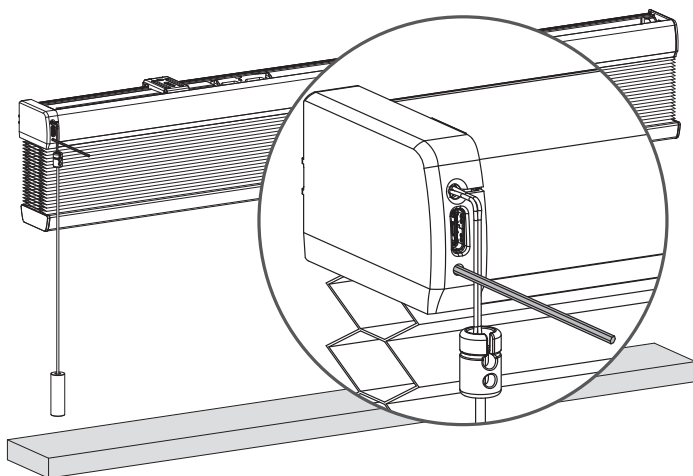

i Deactivate direct control for remote control

When pressing the up or down button on the remote control, the blind directly moves to its end positions (direct control). To operate the blind with smaller steps using the up and down button, direct control can be deactivated. Now, the blind only directly moves to its end positions when the up or down button is held longer than two seconds.

- 1** Press the program button on the motor to activate program mode. The blind starts stepping.
- 2** Hold the program button until the blind stops stepping (approximately 5 seconds) to deactivate or reactivate direct control.

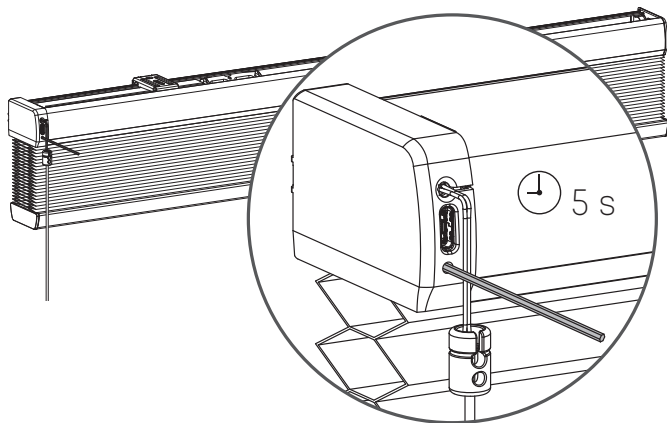

1 Top-down/bottom-up (bottom rail)

Top-down/bottom-up blinds are powered by two motors: one for the bottom rail and one for the middle rail. The motors need to be programmed individually: first the bottom rail motor and then the middle rail motor.

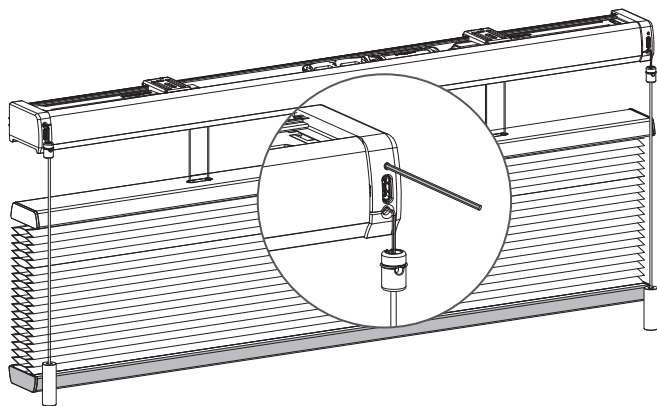

- 1 Pair the bottom rail motor to an empty channel on the remote. (see step 1)

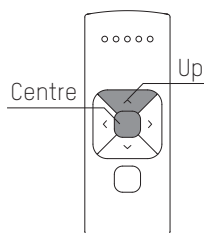
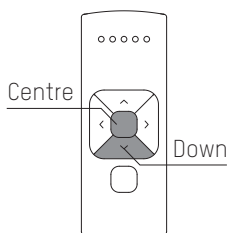

- 2 Check the direction of rotation of the bottom rail (see step 2) and move the bottom rail to the desired top position. Simultaneously hold the centre and the down button on the remote until the blind stops stepping and starts stepping again. The top position has been saved
- 3 Move the bottom rail to the desired bottom position. Program the bottom position of the bottom bar. Simultaneously hold the centre and the up button on the remote until the blind stops stepping and starts stepping again. The bottom position has been saved

2 Top-down/bottom-up (middle rail)

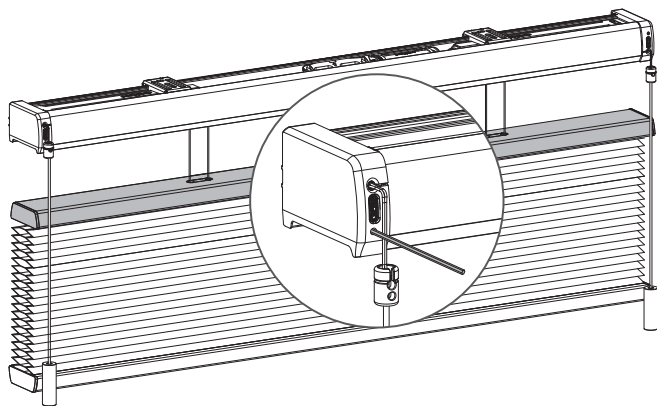

- 1 Pair the middle rail motor to an empty channel on the remote. (see step 1)

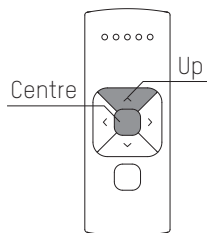
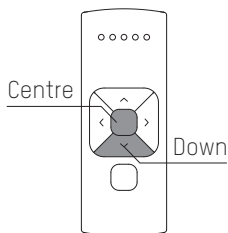
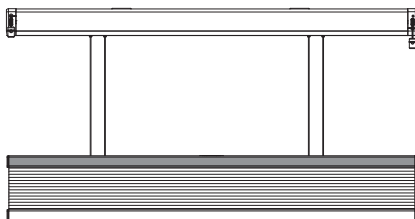
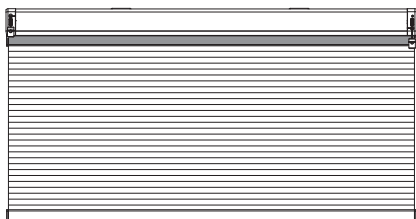

- 2 Check the direction of rotation of the middle rail (see step 2) and move the bottom rail to the desired top position. Simultaneously hold the centre and the down button on the remote until the blind stops stepping and starts stepping again. The top position has been saved
- 3 Move the middle rail to the desired bottom position. Program the bottom position of the bottom bar. Simultaneously hold the centre and the up button on the remote until the blind stops stepping and starts stepping again. The bottom position has been saved

i Activate / deactivate the motor (Transport mode)

To prevent the blind from getting damaged, the motor has a transport mode that makes sure the blind will not be activated before installation.

- 1** Hold the program button and pull twice to activate or deactivate the motor.

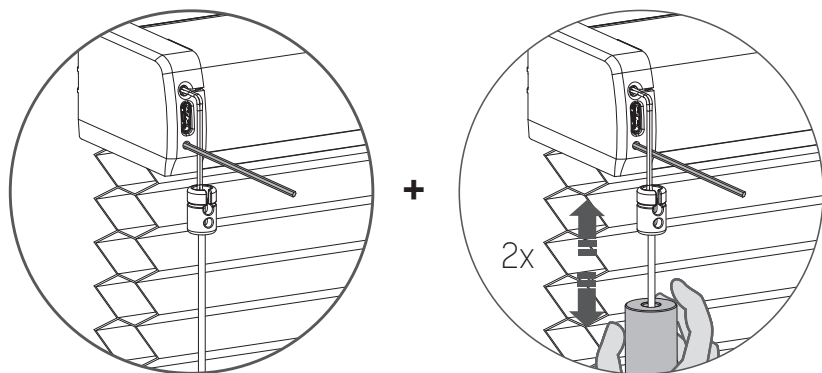

Problem	Cause	Solution
Blind does not work.	Motor is in transport mode.	Activate the motor. See page 2/22.
	Motor battery is empty.	Charge the motor. See page 10.
	Remote battery is empty. (LEDS of remote are flashing rapidly.)	Replace the battery in the remote. See the manual of the remote.
	Remote battery is inserted incorrectly.	Replace the battery in the remote. See the manual of the remote.
	Radio-frequency interference	Make sure that the antenna of the motor is out of the way of metal objects.
	The distance from the phone/bridge/remote to the motor is too far.	Move closer to the motor.
	The remote is not connected to the blind.	Pair the remote with the motor. See page 9.
Motor LED flashes red.	The battery of the motor is empty.	Charge the motor. See page 10.
Blind is not charging.	Charger is not plugged in or does not work.	Try a different charger or make sure the charger is plugged in the outlet.
Multiple blinds respond to a remote. (Unable to program a single blind)	Multiple blinds are paired with a single channel.	Pair the blind with a free channel to program or use single select to program the blind.
Blind moves in small steps.	1) No end limits are programmed. 2) Direct control is deactivated.	1) Program end limits. See page 7, 15-16. 2) Activate direct control. See page 18.
Favourite position can not be programmed.	No end limits are programmed.	Program end limits. See page 7, 14-15, 23-24.
Blind lowers too far.	End limits are programmed incorrectly.	Reprogram end limits. See step 7, 15-16.
Blind moves in the opposite direction.	The rotational direction has been set incorrectly.	Change the rotational direction. See page 14.
The blind keeps moving up and down.	The blind is in program mode.	Press the program button on the motor to exit program mode.
The blind firmware will not update to the latest version.	The blinds bluetooth connection is not stable.	1) Close the app and reconnect with your motor. 2) De-activate the motor and re-activate the motor and try to update again. See page 22

MOTION

MANUAL CM-20

MOTION Wi-Fi bridge

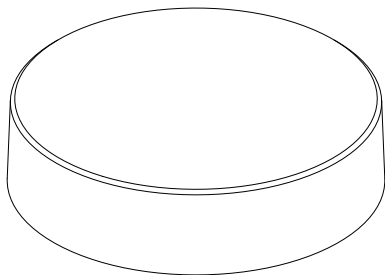

The MOTION Wi-Fi bridge is the heart of your automated blinds network at home. The bridge unlocks endless possibilities to operate blinds with the MOTION app. Cloud connections with leading smart home applications enable voice control and a variety of smart automation options.

Max. blinds	Scenes	Timers	Frequency	Range radio	Power supply	Length	Height	Certificates
30	20	20	433 MHz 2.4 GHz	30 m	USB-C DC 5V 1A	100 mm ø	25 mm	CE FC

This box includes the following items:

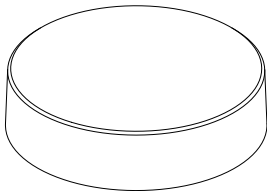

CM-20 MOTION Wi-Fi Bridge

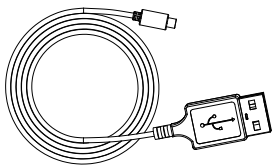

USB-C cable 75cm



For the latest information and updated manuals, visit rtube.nl/cm-20

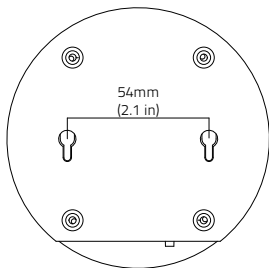
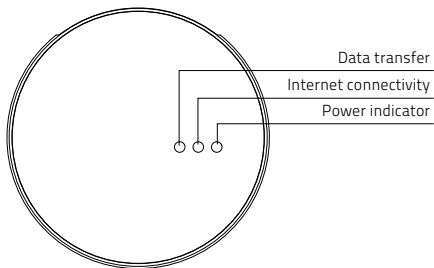
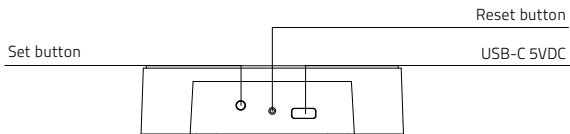

Regulatory Information

1 FCC Information for User

This product does not contain any user-serviceable components and is to be used with approved antennas only. Any product changes or modifications will invalidate all applicable regulatory certifications and approvals.

2 FCC Electronic Emission Notices

This device complies with part 15 of the FCC Rules. Operation is subject to the following two conditions:

1. This device may not cause harmful interference
2. This device must accept any interference received, including interference that may cause undesired operation.

3 FCC Radio Frequency Interference Statement

This equipment has been tested and found to comply with the limits for a class B digital device, pursuant to Part 15 of the FCC Rules. These limits are designed to provide reasonable protection against harmful interference when the equipment is operated in a commercial environment. This equipment generates, uses and can radiate radio-frequency energy and, if not installed and used in accordance with the instructions, may cause harmful interference to radio communications. Operation of this equipment in a residential area may cause harmful interference, in which case the user will be required to correct the interference at their own expense.

If this equipment does cause harmful interference to radio or television reception, which can be determined by turning the equipment off and on, the user is encouraged to try to correct the interference by one or more of the following measures:

- Reorient or relocate the receiving antenna
- Increase the distance separating the equipment and receiver
- Connect the equipment to an outlet on a circuit different from that to which the receiver is connected
- Consult the dealer or an experienced radio/TV technician for help

Safety

WARNING: Important safety instructions. Follow all instructions, since incorrect installation can lead to severe injury.

- Do not let children play with the blind and/or remote control.
- Take care that the blind can move freely and is not blocked by any objects.
- Do not paint the device.
- Keep the device dry.
- Do not drop, knock, or shake the device. Rough handling can break internal circuit boards.
- Do not ingest battery, Chemical Burn Hazard" or equivalent wording
- This product contains a coin / button cell battery. If the coin / button cell battery is swallowed, it can cause severe internal burns in just 2 hours and can lead to death.
- Keep new and used batteries away from children. If the battery compartment does not close securely, stop using the product and keep it away from children. If you think batteries might have been swallowed or placed inside any part of the body, seek immediate medical attention.

Cleaning

Follow these general rules when cleaning the outside of the device and its components:

- Use a damp, soft, lint-free cloth. Avoid getting moisture in openings.
- Do not use aerosol sprays, solvents, alcohol, or abrasives.

Service & Support

Do not perform repairs yourself. Do not attempt to open the device or disassemble it. You run the risk of electric shock and voiding the limited warranty. No user-serviceable parts are inside.

Warranty Service

First follow the advice in this manual. If the product appears to be damaged or does not function properly, go to your local dealer for instructions on how to obtain warranty service.

Recycle

This marking indicates that this product should not be disposed with other household wastes throughout the EU. To prevent possible harm to the environment or human health from uncontrolled waste disposal, recycle it responsibly to promote the sustainable reuse of material resources. To return your used device, please use the return and collection systems or contact the retailer where the product was purchased. They can take this product for environmental safe recycling.

EU Declaration

Hereby, Coulisse declares that the radio equipment type CM20 is in compliance with directive 2014/53/EU The full text of the EU declaration of conformity is available at the following internet address: www.coulisse.com

1 Download the app and create an account

- i** The MOTION Wi-Fi bridge needs to be set up with the MOTION Blinds app before installation on the wall or ceiling. Download the MOTION Blinds app from the App Store or Google Play with your smartphone or tablet. Open the MOTION app and create an account.



App Store
Download the
MOTION Blinds app
rtube.nl/red981



Google Play
Download the
MOTION Blinds app
rtube.nl/red982



2 Power the bridge

- i** There is no charger included with this product. Any universal DC 5V 1A USB charger can be used to power the MOTION bridge.

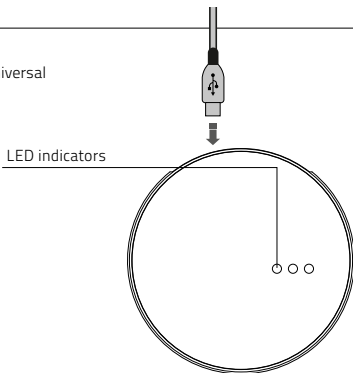
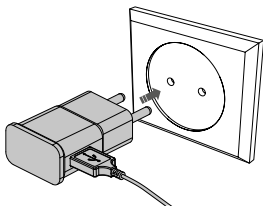

MOTION LED indicators

LED	Color	Status
Right	Solid Red	Bridge is powered on
Center	Blinking purple	Bridge connecting mode
Center	Blinking red	Not connected to Wi-Fi
Center	Solid Yellow	Connected to Wi-Fi, not connected to MOTION cloud
Center	Solid Blue	Connected to Wi-Fi Connected to MOTION cloud
Left	Blinking purple	Pairing blind with bridge
Left Center	Blinking green Solid blue	Bridge firmware update

3 Connect the bridge to a Wi-Fi network





- i** An active internet connection is required to add the MOTION bridge to your home Wi-Fi network. Choose a location for the MOTION bridge in your home. Connect your smartphone or tablet to your home Wi-Fi network to check the strength of the Wi-Fi signal at this location. To avoid interference please make sure the MOTION bridge is located at least one meter away from any other Wi-Fi devices, including your router.

Note: this item only works on a 2,4GHz Wifi network, not on a 5GHz WiFi network. Please consult the manual of your router for settings.



Video
MOTION app:
how it works
rtube.nl/red1074



3G/4G	✗
	✗
	✗
	✓
	✓



- 3.1** Choose 'Edit' at the top right of your screen and open 'Settings'.

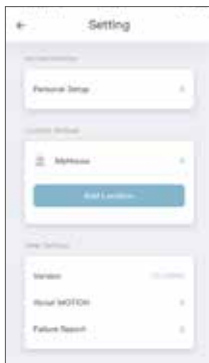

- 3.2** Click on your location (MyHouse) to add the MOTION bridge to this location.



- 3.3** Press 'Add Bridge' and follow the installation wizard to setup your bridge.

The MOTION Blinds app allows to create 5 different locations. Up to 3 bridges can be added per location.



- 3.4** Make sure the MOTION bridge is powered ON. Open the Wi-Fi settings of your mobile device and connect to the Wi-Fi network you want to connect the MOTION bridge with.



- 3.5** Return to the MOTION Blinds app and enter the password of the Wi-Fi network.



- 3.6** Press and hold the 'Set' button on the MOTION bridge until the LED on top of the bridge starts to flash purple. Go to the app and press 'Connect'. Now a MOTION Wi-Fi network is created by the bridge.



- 3.7 Keep the MOTION Blinds app running on the background, while opening the Wi-Fi settings of your mobile device.



- 3.8 Choose the MOTION_XXXX network to connect with the bridge. Return to the MOTION Blinds app to finish the installation wizard.



- 3.9 The bridge automatically connects to your Wi-Fi network. The middle LED on the bridge first turns yellow and then blue. Now the bridge is connected to your Wi-Fi network and the MOTION cloud.

4 Add a blind



- 4.1 Go back to the start screen in the app and open your location.

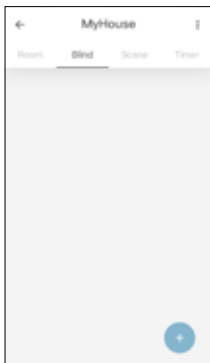

- 4.2 Navigate to 'Blind' and press the '+' button to add a new blind. (Make sure your blind has a top and bottom position programmed. If your blind does not have end positions please program first.)

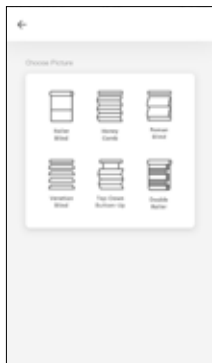

- 4.3 Choose the blind type and follow the setup wizard.

i Before adding a blind to the MOTION bridge, the end positions of the blind must be programmed with a remote control.

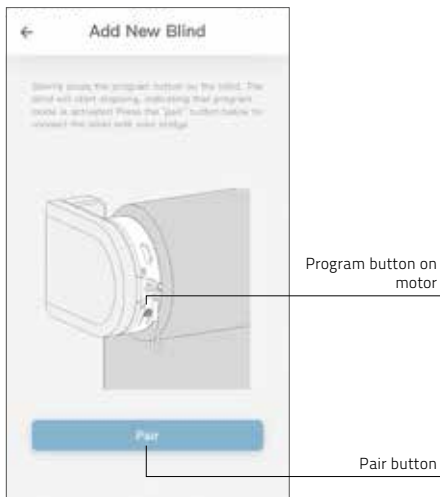

4.4

Shortly press the program button on the blind. (Please see the manual of your motor to see where the program button is located.) The blind will start stepping, indicating that program mode is activated. Press the 'pair' button to connect the blind with your bridge.

5 Roller/ Honeycomb/ Roman blind control

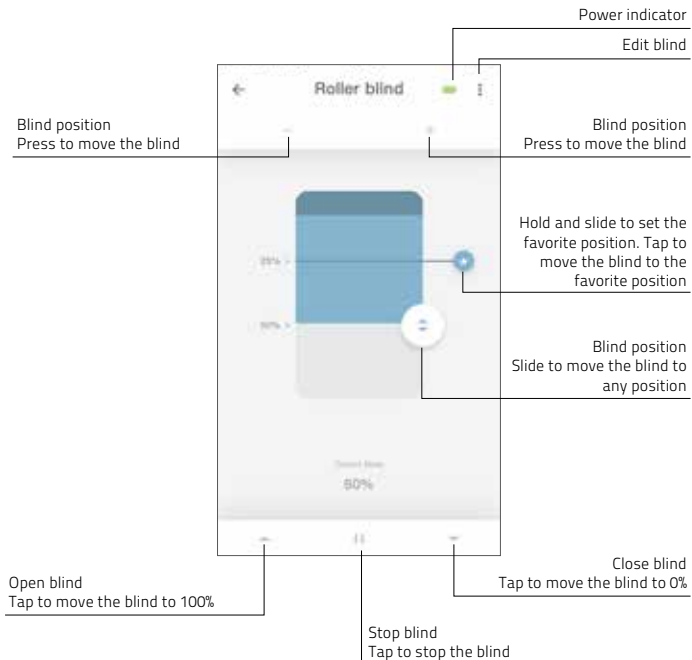

6 Double roller control

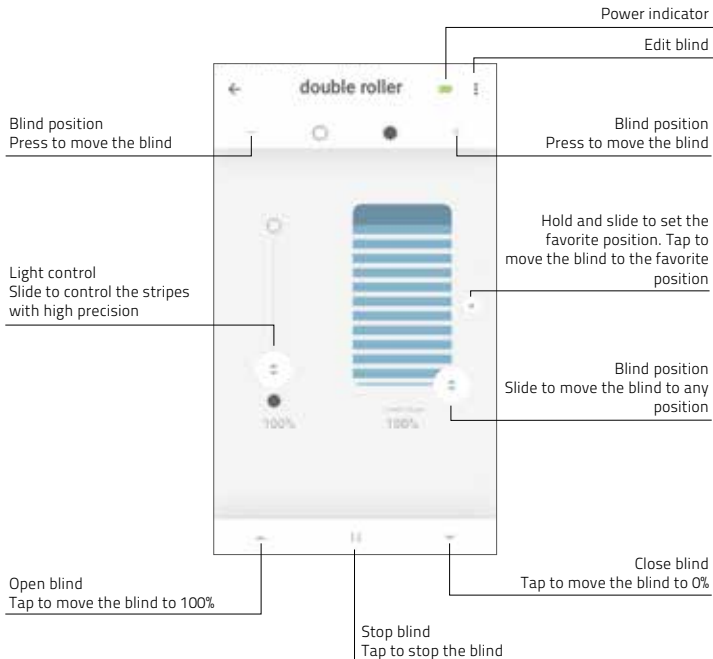

7 Top-down/Bottom-up control

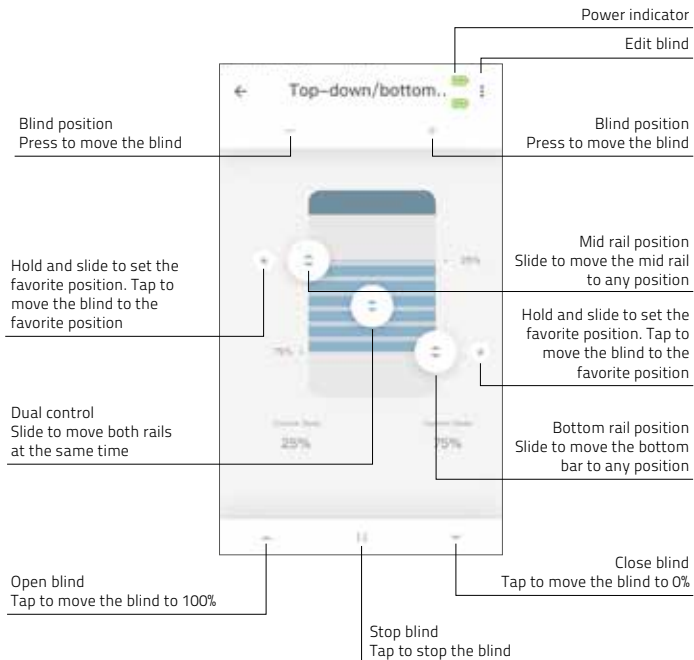

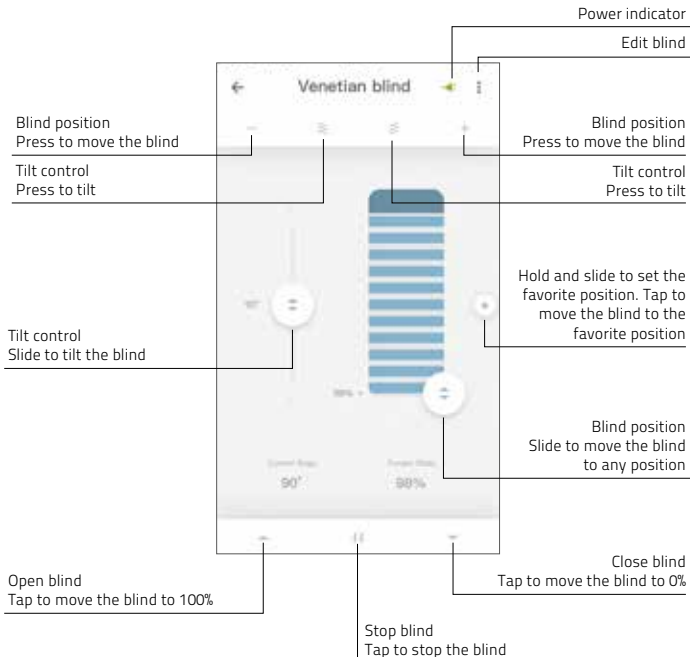

9 Create a room

i Add blinds to a room to control individual blinds or all blinds in a room at the same time. Shortly click on a room to see/control all the blinds in this room



Add room

9.1 Press the '+' button to add a new room.

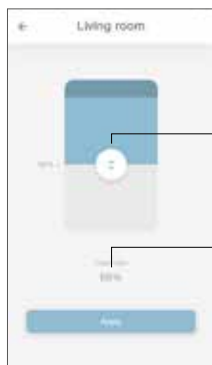

Position slider

Target Position

9.2 Click and hold on a room and control all the blinds to a certain position.

10 Create a scene

i Scenes can be created to move your blinds to preset positions.

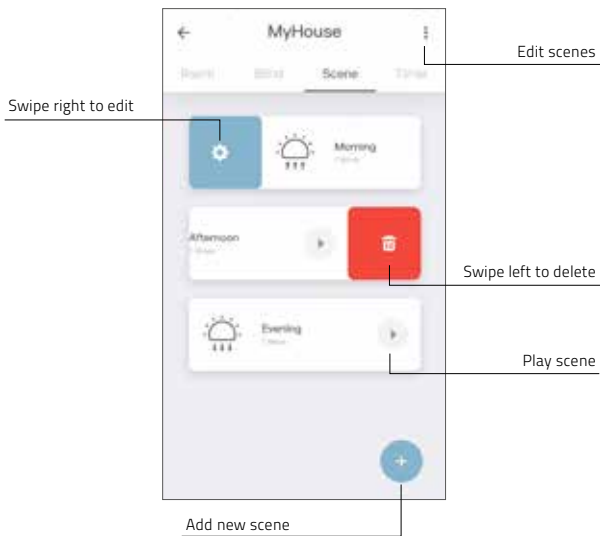

11 Create a timer

i Timers can be created to automate blinds and scenes to make the home seem inhabited.

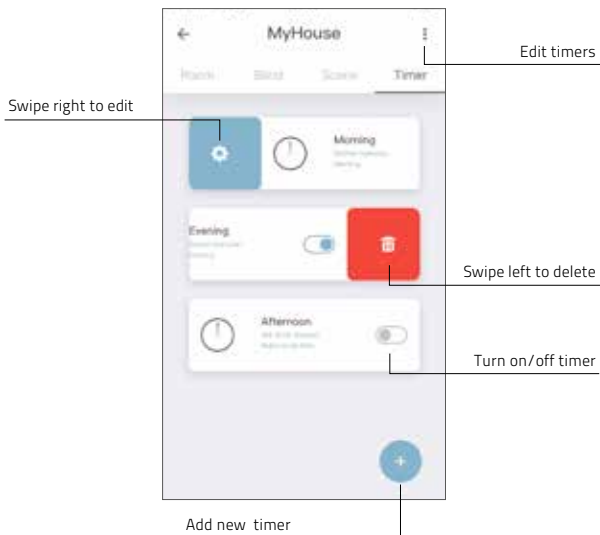

12 Connect to third party

i The MOTION bridge allows to seamlessly connect motorised blinds to smart home applications. Scan the QR code below to discover the third party connections.

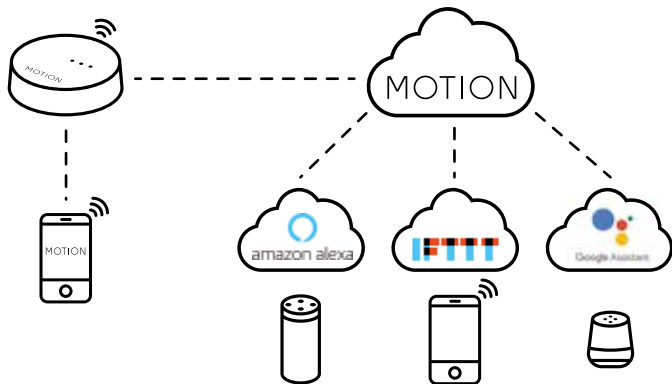

Third party
Discover third party
connections for MOTION
blinds rtube.nl/red1062



13 Frequently Asked Questions

Problem	Cause	Solution
Blind is not responding	Motor battery is empty	Charge the motor. See the manual of your motor
	Radio interference / shielding	Make sure that the bridge/antenna of the motor is out of the way from metal objects
	The distance from the bridge to the motor is too far	Move the bridge closer to the blind
	The bridge is turned off	Power the bridge
Can not pair your bridge	Wrong password	Start the setup wizard again and use the right password. The password is case sensitive
	Router does not give an IP address to the bridge	Press and hold the reset button for 10 seconds. The center LED indicator will be RED. Retry to add the bridge
	Bridge is trying to connect with 5GHz .	Please consult the manual of your router to temporarily turn off your 5GHz in the router settings.

All rights reserved. No part of this publication may be reproduced, stored in a retrieval system, or transmitted, in any form, by any means, electronic, mechanical, photocopying, recording, digital or otherwise without the written permission of the publisher.

Although this manual has been composed with the utmost care, Coullisse b.v. does not accept any responsibility for damage due to mistakes and/or faults in this manual. Coullisse b.v. reserves the right to revise the manual and to revise and/or change its content at any time, without obligation to notify any person or entity of such revisions or changes.

MOTION

GEBRAUCHSANWEISUNG CM-20

Motion WLAN-Bridge

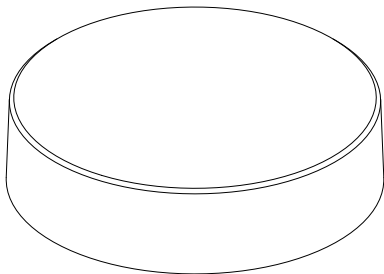

Die MOTION-WLAN-Bridge ist das Herzstück des automatischen Rollo-Netzwerks in Ihrem Haus. Die Bridge eröffnet Ihnen unzählige Möglichkeiten, um Ihre Rollos über die MOTION-App zu steuern. Cloud-Verbindungen mit den führenden Smart-Home-Anwendungen ermöglichen die Sprachsteuerung und eine Vielzahl an Optionen für die Smart-Automatisierung.

Max. Rollos	Szenen	Timer	Frequenz	Funkbereich	Stromquelle	Länge	Höhe	Zertifikate
30	20	20	433 MHz 2,4 GHz	30 m	USB-C DC 5V 1A	100 mm ø	25 mm	CE FC

Im Lieferumfang dieser Box ist Folgendes enthalten:

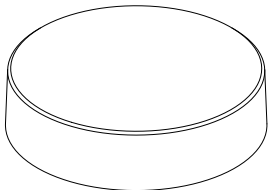

CM-20 MOTION WLAN-Bridge

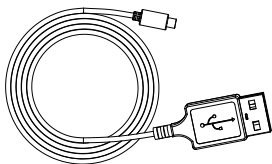

USB-C Kabel 75 cm



Für mehr Informationen und aktualisierte Bedienungsanleitungen besuchen Sie bitte rtube.nl/cm-20

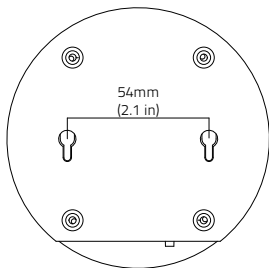
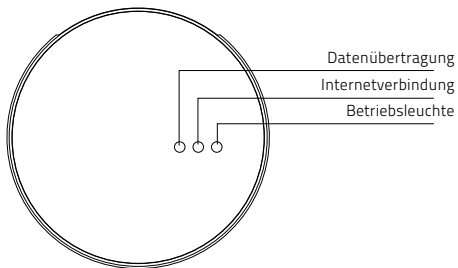
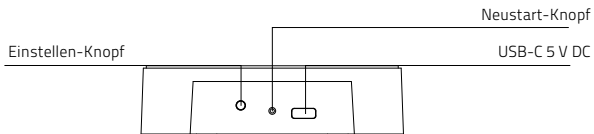

Regulatorische Informationen

1 FCC Information für Benutzer

Dieses Produkt enthält keine durch den Benutzer zu wartenden Komponenten und darf ausschließlich mit genehmigten Antennen verwendet werden.

Jegliche Änderungen oder Modifizierungen des Produkts machen sämtliche regulatorischen Zertifikate und Genehmigungen ungültig.

2 FCC Hinweis zu elektronischen Emissionen

Dieses Gerät entspricht Abschnitt 15 der FCC-Richtlinien. Bei Betrieb müssen die folgenden zwei Bedingungen erfüllt sein:

1. Dieses Gerät darf keine schädigenden Interferenzen verursachen
2. Dieses Gerät muss jede empfangene Interferenz akzeptieren, einschließlich Interferenz, die unerwünschten Betrieb zur Folge haben könnte.

3 FCC Funkstörungserklärung

Dieses Gerät wurde getestet. Es wurde festgestellt, dass es die Endpositionen für ein digitales Gerät der Klasse B erfüllt, wie in Abschnitt 15 der FCC-Richtlinien ausgeführt. Diese Begrenzungen dienen dazu, angemessene Sicherheit gegen schädigende Interferenzen zu wahren, wenn das Gerät in einer kommerziellen Umgebung betrieben wird. Dieses Gerät erzeugt und nutzt Hochfrequenzenergie und kann dieselbe ausstrahlen. Wenn es nicht gemäß den Hinweisen installiert und verwendet wird, kann es schädigende Interferenzen für Funkgeräte verursachen.

Der Betrieb dieses Geräts in einer Wohnumgebung kann schädigende Interferenzen verursachen. In diesem Fall muss der Benutzer die Interferenz auf seine eigenen Kosten korrigieren.

Sollte das Gerät schädigende Interferenzen für Radio- oder Fernsehempfang verursachen, was durch das An- und Abschalten des Geräts festgestellt werden kann, sollte der Benutzer versuchen, die Interferenz mit einer oder mehreren der folgenden Methoden zu korrigieren:

- Richten Sie die Empfangsantennen neu aus oder platzieren Sie sie anders
- Vergrößern Sie den Abstand zwischen dem Gerät und dem Empfänger
- Verbinden Sie das Gerät mit einer Steckdose eines anderen Stromkreises als jener, mit dem der Empfänger verbunden ist
- Bitten Sie den Händler oder einen erfahrenen Radio-/TV-Techniker um Rat

Sicherheit

WARNUNG: Wichtige Sicherheitshinweise Befolgen Sie sämtliche Hinweise, da eine fehlerhafte Installation zu ernststen Verletzungen führen kann.

- Lassen Sie Kinder nicht mit dem Rollo und/oder der Fernbedienung spielen.
- Achten Sie darauf, dass das Rollo sich frei bewegen kann und nicht durch Objekte blockiert wird.
- Streichen Sie das Gerät nicht über.
- Halten Sie das Gerät trocken.
- Lassen Sie das Gerät nicht fallen. Schlagen Sie nicht darauf und schütteln Sie es nicht. Durch groben Umgang können interne Leiterplatten beschädigt werden.

- Dieses Produkt enthält eine Knopfzellenbatterie. Wenn eine Knopfzellenbatterie verschluckt wird, kann sie in nur 2 Stunden schwere innere Verbrennungen verursachen und zum Tod führen.
- Halten Sie neue und gebrauchte Batterien von Kindern fern. Wenn sich das Batteriefach nicht sicher schließen lässt, stellen Sie die Verwendung des Produkts ein und halten Sie es von Kindern fern. Wenn Sie glauben, dass Batterien verschluckt oder in einen Körperteil eingeführt worden sein könnten, suchen Sie sofort einen Arzt auf.

Reinigung

Befolgen Sie bei der Reinigung des Geräts und der einzelnen Komponenten diese allgemeinen Regeln:

- Verwenden Sie ein feuchtes, weiches und fusselfreies Tuch. Achten Sie darauf, dass keine Feuchtigkeit in Öffnungen eindringt.
- Verwenden Sie keine Sprays, Lösungsmittel, Alkohol oder Scheuermittel.

Service & Support

Führen Sie Reparaturen nie selbst durch. Versuchen Sie nicht, das Gerät zu öffnen oder auseinanderzunehmen. Sie riskieren einen Elektroschock und setzen gegebenenfalls die Garantie außer Kraft. Es befinden sich keine durch den Benutzer zu wartenden Teile im Inneren des Geräts.

Garantieservice

Folgen Sie zunächst den Hinweisen dieser Bedienungsanleitung. Sollte das Produkt beschädigt sein oder nicht korrekt funktionieren, wenden Sie sich bitte an einen Vertragshändler vor Ort, um gegebenenfalls die Produktgarantie in Anspruch zu nehmen.

Recycling

Diese Kennzeichnung weist darauf hin, dass dieses Produkt in der gesamten EU nicht mit anderen Haushaltsabfällen entsorgt werden sollte. Um eine mögliche Schädigung der Umwelt oder der menschlichen Gesundheit durch unkontrollierte Abfallentsorgung zu verhindern, sollte es verantwortungsbewusst recycelt werden, um eine nachhaltige Wiederverwendung von Materialressourcen zu fördern. Zur Rückgabe Ihres gebrauchten Geräts nutzen Sie bitte die Rückgabe- und Sammelsysteme oder wenden Sie sich an den Händler, bei dem das Produkt gekauft wurde. Dort kann dieses Produkt für ein umweltgerechtes Recycling abgegeben werden.

EU-Erklärung

Hiermit erklärt Coulisse, dass die Funkvorrichtung vom Typ CM20 mit der Richtlinie 2014/53/EU konform ist. Der vollständige Text der EU-Konformitätserklärung ist unter der Internetadresse www.coulisse.com verfügbar.

1 Laden Sie die App herunter und erstellen Sie einen Account

- i** Die MOTION-WLAN-Bridge muss mit der MOTION-Blinds-App eingerichtet werden, bevor sie an der Wand oder Decke montiert werden kann. Laden Sie die MOTION-Blinds-App aus dem App Store oder Google Play Store auf Ihr Smartphone oder Tablet herunter. Öffnen Sie die MOTION-App und erstellen Sie einen Account.



App Store

Laden Sie die
MOTION-Blinds-App
herunter
rtube.nl/red981



Google Play

Laden Sie die
MOTION-Blinds-
App herunter
rtube.nl/red982



2 Schließen Sie die Bridge an die Stromversorgung an

- i** Dieses Produkt verfügt nicht über ein Ladegerät. Jedes Universal-Ladegerät mit einem DC-5V-1A-USB-Anschluss kann zum Aufladen der MOTION-Bridge verwendet werden.

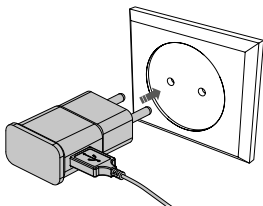

MOTION-LED-Anzeigeleuchten

LED	Farbe	Status
Rechts	rot	Die Bridge ist betriebsbereit
Mitte	violett blinkend	Bridge im Verbindungsmodus
Mitte	rot blinkend	Nicht mit dem WLAN verbunden
Mitte	gelb	Mit dem WLAN verbunden, nicht mit der MOTION-Cloud verbunden
Mitte	blau	Mit dem WLAN verbunden Mit der MOTION-Cloud verbunden
Links	violett blinkend	Das Rollo wird mit der Bridge gekoppelt
Links Mitte	grün blinkend blau	Firmware-Update für die Bridge wird ausgeführt

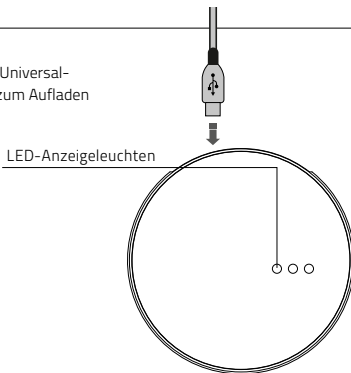

3 Verbinden Sie die Bridge mit einem WLAN-Netz

i Um eine MOTION-Bridge zu Ihrem Heim-WLAN-Netzwerk hinzuzufügen, ist eine aktive Internetverbindung erforderlich.

Wählen Sie den Ort in Ihrem Haus aus, an dem Sie die MOTION-Bridge platzieren möchten.

Verbinden Sie Ihr Smartphone oder Tablet mit Ihrem Heim-WLAN-Netzwerk, um die Stärke des WLAN-Signals an dieser Stelle zu überprüfen.

Stellen Sie sicher, dass die MOTION-Bridge mindestens einen Meter von anderen WLAN-Geräten, einschließlich Ihres Routers, entfernt platziert wird, um Störungen vorzubeugen.

Hinweis: Dieser Artikel funktioniert nur in einem 2,4GHz-Wifi-Netzwerk, nicht in einem 5GHz-Wifi-Netzwerk. Bitte schlagen Sie im Handbuch Ihres Routers die Einstellungen nach.



Video
MOTION App:
wie es funktioniert
rtube.nl/red1074



3G/4G	✗
	✗
	✗
	✓
	✓



- 3.1** Wählen Sie oben rechts auf dem Bildschirm 'Edit' (Bearbeiten) aus und öffnen Sie „Settings (Einstellungen).

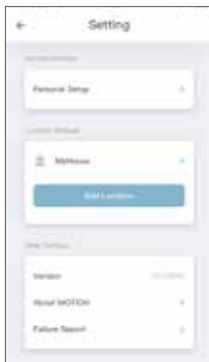

- 3.2** Tippen Sie auf Ihren Standort (MyHouse), um die MOTION-Bridge zu diesem Standort hinzuzufügen.

Die MOTION-Blinds-App ermöglicht es Ihnen, 5 verschiedene Standorte zu erstellen. Pro Standort können Sie bis zu 3 Bridges hinzufügen.



- 3.3** Tippen Sie auf 'Add' Bridge (Brücke hinzufügen) und folgen Sie den Installationsanweisungen, um Ihre Bridge einzurichten.



- 3.4** Stellen Sie sicher, dass die MOTION-Bridge betriebsbereit ist. Öffnen Sie die WLAN-Einstellungen Ihres mobilen Endgeräts und verbinden Sie sich mit dem WLAN-Netzwerk, mit dem Sie die MOTION-Bridge verbinden möchten.



- 3.5** Kehren Sie zur MOTION-Blinds-App zurück und geben Sie das Passwort für das WLAN-Netzwerk ein.



- 3.6** Drücken Sie den 'Einstellen'-Knopf an der MOTION-Bridge und halten Sie ihn gedrückt, bis die LED oben auf der Bridge violett zu blinken beginnt. Rufen Sie die App auf und tippen Sie auf 'Connect' (Verbinden). Nun ist ein MOTION-WLAN-Netzwerk auf der Bridge eingerichtet.



3.7

Lassen Sie die MOTION-Blinds-App im Hintergrund laufen, während Sie die WLAN-Einstellungen Ihres mobilen Endgeräts öffnen.



3.8

Wählen Sie das Netzwerk MOTION_XXXX aus, um es mit der Bridge zu verbinden. Kehren Sie zur MOTION-Blinds-App zurück, um die Installation abzuschließen.

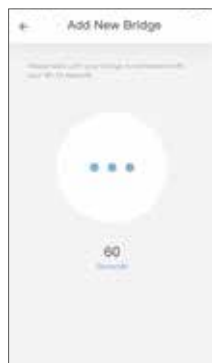

3.9

Die Bridge verbindet sich automatisch mit Ihrem WLAN-Netzwerk. Die mittlere LED auf der Bridge wechselt zunächst zu gelb und dann zu blau. Nun ist die Bridge mit Ihrem WLAN-Netzwerk und der MOTION-Cloud verbunden.

4 Fügen Sie ein Rollo hinzu

i Bevor Sie ein Rollo zur MOTION-Bridge hinzufügen, müssen die Endpositionen des Rollos mit einer Fernbedienung programmiert werden.



4.1 Rufen Sie erneut den Startbildschirm der App auf und öffnen Sie Ihren Standort.



4.2 Rufen Sie 'Blind' (Rollo) auf und tippen Sie auf '+', um ein neues Rollo hinzuzufügen. (Stellen Sie zunächst sicher, dass für Ihr Rollo eine obere und eine untere Position programmiert ist. Wenn für Ihr Rollo noch keine Endpositionen programmiert sind, tun Sie dies bitte zunächst).

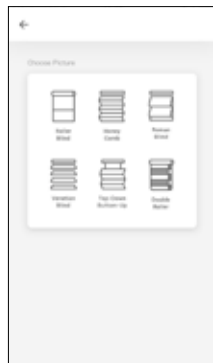

4.3 Wählen Sie die Art des Rollos aus und folgen Sie der Installationsanleitung.

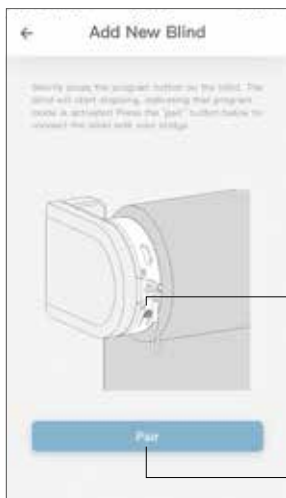

Programm-Knopf
auf dem Motor

Kopplungsknopf

4.4

Drücken Sie kurz auf den Programm-Knopf am Rollo. (Nehmen Sie bitte das Handbuch Ihres Motors zur Hilfe, um nachzusehen, wo sich der Programm-Knopf befindet). Das Rollo beginnt, sich schrittweise zu bewegen, um anzuzeigen, dass der Programmiermodus aktiviert wurde. Drücken Sie den Kopplungsknopf, um das Rollo mit der Bridge zu koppeln.

5 Steuerung Rollo / Waben / Römisches Rollo

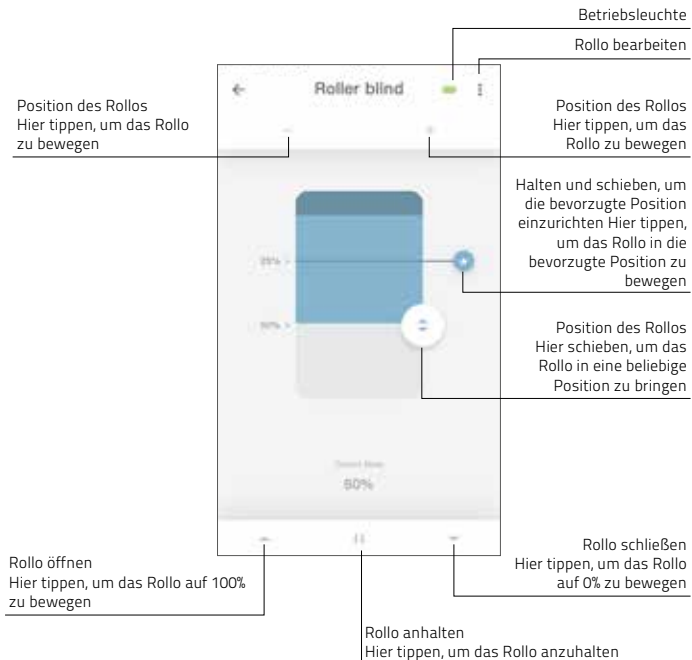

6 Doppelrollo-Steuerung

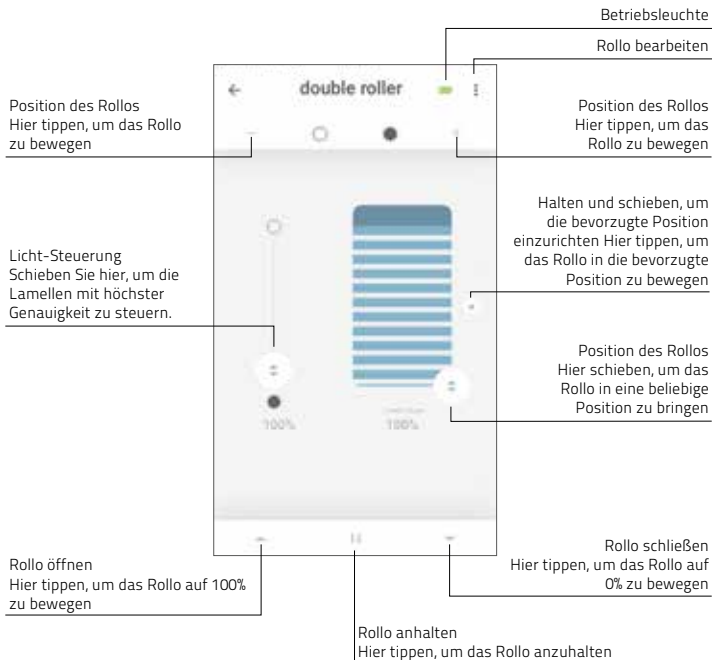

7

Steuerung von oben nach unten/von unten nach oben

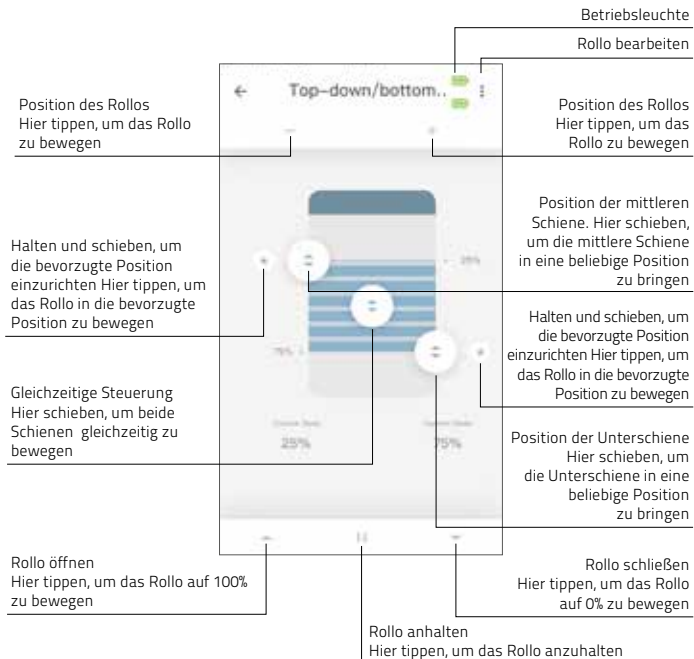

8 Horizontale Steuerung

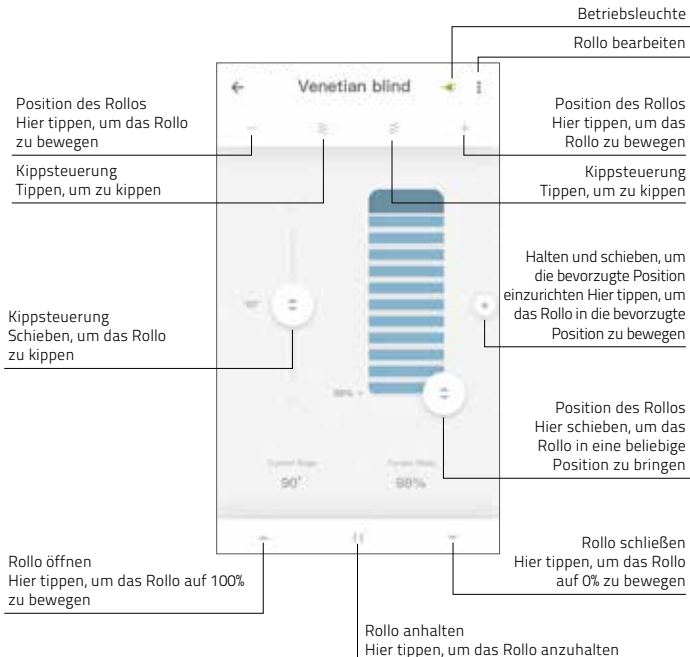

9 Einen Raum erstellen



Add room

- 9.1** Tippen Sie auf '+', um einen neuen Raum hinzuzufügen.

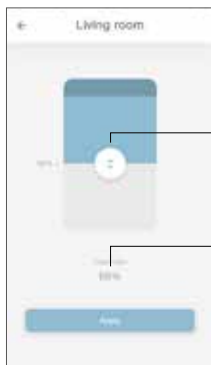

Positionsschieber

Zielposition

- 9.2** Tippen Sie auf einen Raum und halten Sie ihn gedrückt, um alle Rollos in eine bestimmte Position zu bringen.

i Fügen Sie einem Raum Rollos hinzu, um einzelne Rollos oder alle Rollos in einem Raum gleichzeitig steuern zu können. Tippen Sie kurz auch einen Raum, um alle Rollos in diesem Raum anzuzeigen/zusteuern.

10 Eine Szene erstellen

i Szenen können erstellt werden, um Ihre Rollos in voreingestellte Positionen zu bringen.

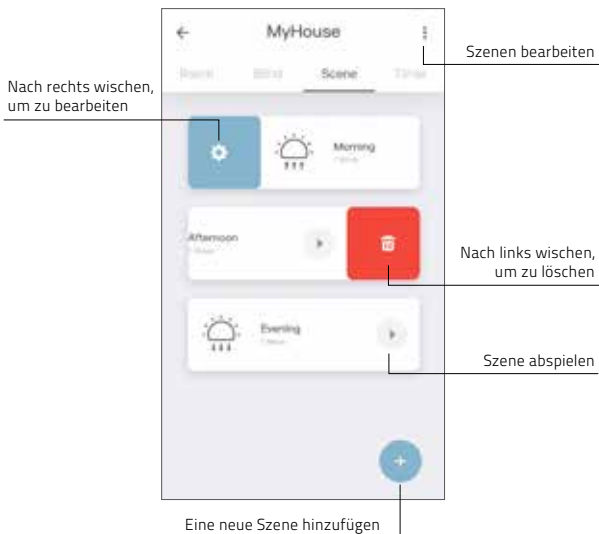

11 Einen Timer erstellen

i Es können Timer eingerichtet werden, um Rollos und Szenen zu automatisieren und ein Haus bewohnt erscheinen zu lassen.

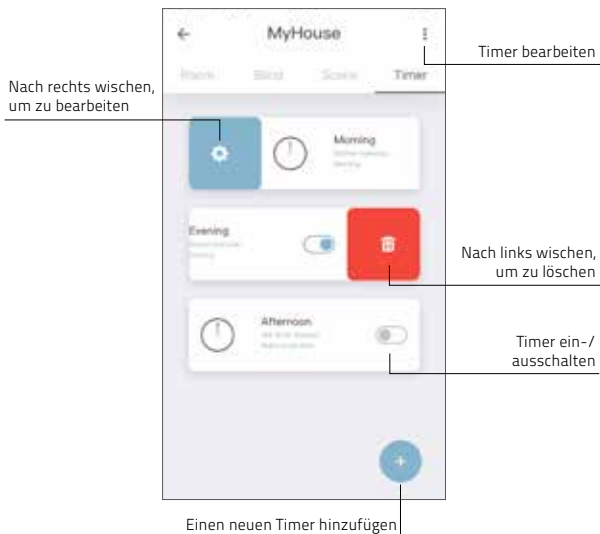

12 Verbindungen mit Drittanbietern

- i** Die MOTION-Bridge ermöglicht es, motorisierte Rollos nahtlos mit Smart-Home-Anwendungen zu verbinden. Scannen Sie den QR-Code unten, um mehr über Verbindungen mit Drittanbietern zu erfahren.

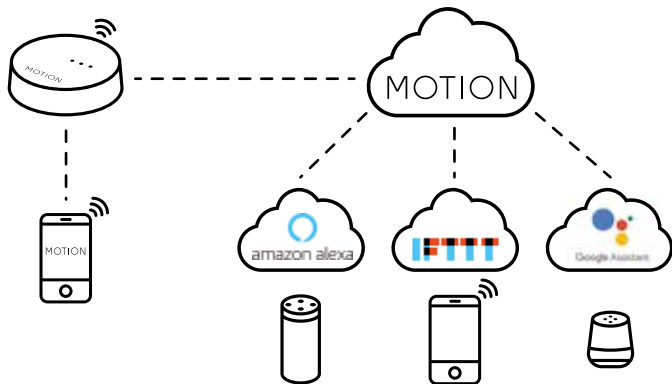

Drittanbieter

Entdecken Sie, wie Sie
MOTION-Rollos mit
Drittanbieter-Anwendungen
verbinden rtube.nl/red1062



13 Häufig gestellte Fragen

Problem	Grund	Lösung
Rollo reagiert nicht	Motorbatterie ist leer	Laden Sie den Motor auf. Siehe Handbuch des Motors
	Funkstörung / -abschirmung	Stellen Sie sicher, dass die Bridge/Antenne des Motors nicht von Metallgegenständen blockiert wird
	Die Entfernung zwischen Bridge und Motor ist zu weit	Positionieren Sie die Bridge näher am Rollo
	Die Bridge ist ausgeschaltet	Schließen Sie die Bridge an die Stromversorgung an
Die Kopplung der Bridge schlägt fehl	Falsches Passwort	Starten Sie des Installationsprogramm erneut und verwenden Sie das richtige Passwort. Bei der Eingabe ist auf die Groß- und Kleinschreibung zu achten
	Der Router vergibt der Bridge keine IP-Adresse	Drücken Sie den Neustart-Knopf und halten Sie ihn für 10 Sekunden gedrückt. Die Mittlere LED-Anzeigelampe wird rot leuchten. Versuchen Sie erneut, die Bridge hinzuzufügen
	Die Bridge versucht, eine Verbindung mit dem 5GHz-Netz herzustellen	Bitte lesen Sie im Handbuch Ihres Routers nach, um Ihr 5GHz-Netz in den Router-Einstellungen vorübergehend abzuschalten.

Alle Rechte vorbehalten. Keine der hier aufgeführten Inhalte dürfen ohne schriftliche Zustimmung des Herausgebers reproduziert, in elektronischen Systemen verarbeitet oder gespeichert werden, weder elektronisch, noch maschinell, bildtechnisch, digital oder auf irgendeine andere Art und Weise. Obwohl diese Bedienungsanleitung sorgfältig zusammengestellt wurde, können Fehler enthalten sein. Coulisse b.v. ist nicht verantwortlich für Schäden, die aufgrund von fehlerhaften Informationen in dieser Bedienungsanleitung zustande gekommen sind, und übernimmt keinerlei Haftung. Coulisse b.v. behält sich das Recht vor, diese Bedienungsanleitung jederzeit zu überarbeiten und im Zuge dessen die Inhalte zu ändern. Coulisse B.V. ist nicht dazu verpflichtet, Personen oder Institutionen über vorgenommene Änderungen in dieser Bedienungsanleitung zu informieren.

MOTION

MANUEL CM-20

Pont Motion Wi-Fi

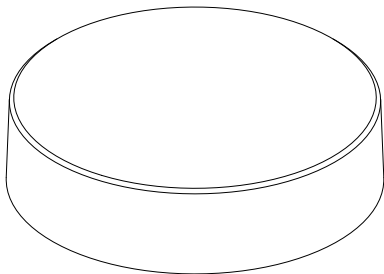

Le pont MOTION Wi-Fi est le cœur de votre réseau de stores automatisé à la maison. Le pont déverrouille des possibilités infinies d'utiliser des stores avec l'appli MOTION. Les connexions en nuage avec les principales applications domestiques intelligentes permettent un contrôle vocal et une variété d'options d'automatisation intelligente.

Max. stores	Scènes	Minuteries	Fréquence	Portée radio	Alimentation	Longueur	Hauteur	Certificats
30	20	20	433 MHz 2.4 GHz	30 m	USB-C DC 5V 1A	100 mm ø	25 mm	CE FC

Cette boîte comprend les éléments

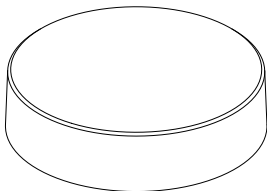

CM-20 Pont Motion Wi-Fi

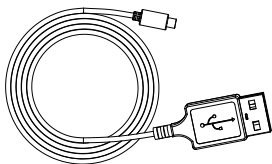

Câble USB-C 75 cm



Pour les dernières informations et les manuels mis à jour, rendez-vous sur rtube.nl/cm-20

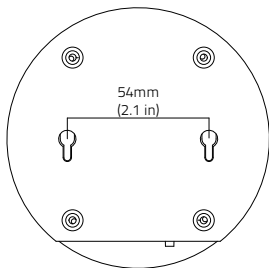
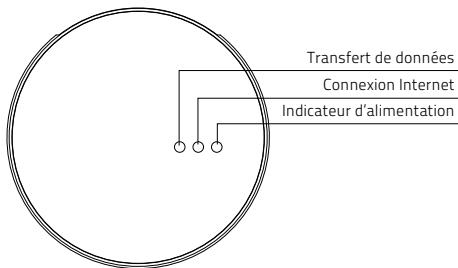
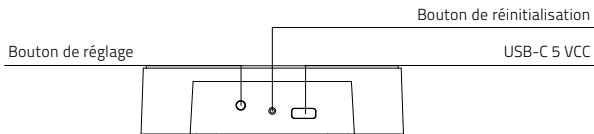

Manuel FCC | FCC ID : ZY4CM18

Informations relatives à la réglementation

1 Informations FCC à l'utilisateur

Ce produit ne contient aucun composant réparable par l'utilisateur et ne doit être utilisé qu'avec des antennes agréées. Tout changement ou modification de produit annulera toutes les certifications et approbations réglementaires applicables.

2 Avis d'émission électroniques de la FCC

Cet appareil est conforme à la partie 15 du règlement de la FCC. Son utilisation est soumise aux deux conditions suivantes :

1. Cet appareil ne doit causer aucune interférence nuisible
2. Cet appareil doit accepter toute interférence reçue, y compris des interférences qui peuvent provoquer un fonctionnement non désiré.

3 Déclaration d'interférence des fréquences radio de la FCC

Cet équipement a été testé et déclaré conforme aux limites d'un dispositif numérique de classe B, conformément à la Partie 15 des règles de la FCC. Ces limites sont conçues pour fournir une protection raisonnable contre les interférences nuisibles lorsque l'équipement est utilisé dans un environnement commercial. Cet équipement génère, utilise et peut émettre de l'énergie de fréquence radio et, s'il n'est pas installé et utilisé

conformément aux instructions, il peut causer des interférences nuisibles aux communications radio. Le fonctionnement de cet équipement dans une zone résidentielle peut générer des interférences préjudiciables, auquel cas il appartiendra à l'utilisateur de corriger les interférences à ses frais. Si cet équipement provoque effectivement une interférence préjudiciable à la réception radio ou télévisuelle, ce qui peut être établi en éteignant et en rallumant l'équipement, l'utilisateur est invité à tenter de corriger l'interférence par une ou plusieurs des mesures suivantes :

- Réorienter ou repositionner l'antenne de réception
- Augmenter la distance entre l'équipement et le récepteur
- Brancher l'équipement sur une prise d'alimentation ou sur un circuit différent de celui où le récepteur est branché
- Consulter le revendeur ou un technicien radio/télévision expérimenté pour obtenir de l'aide

Sécurité

ATTENTION : instructions de sécurité importantes. Suivez toutes les instructions, car une installation incorrecte peut entraîner des blessures graves.

- Ne laissez pas les enfants jouer avec le store et / ou la télécommande.
- Veillez à ce que le store puisse se déplacer librement et ne soit pas bloqué par des objets.
- Ne peignez pas l'appareil.
- Gardez l'appareil au sec.
- Ne laissez pas tomber, frapper ou secouer l'appareil. Une manipulation brutale peut endommager les circuits internes.
- Ce produit contient une pile bouton / de montre. L'ingestion de la pile bouton / de montre peut causer de graves brûlures internes en seulement 2 heures et entraîner la mort.
- Tenez les piles neuves et usagées hors de portée des enfants. Si le compartiment à pile ne se ferme pas bien, cessez d'utiliser le produit et tenez-le hors de portée des enfants. Si vous pensez que les piles peuvent avoir été avalées ou insérées dans quelque partie du corps, consultez immédiatement un médecin.

Nettoyage

Suivez ces règles générales lors du nettoyage de l'extérieur de l'appareil et de ses composants :

- Utilisez un chiffon humide, doux et non pelucheux. Évitez les infiltrations d'humidité par les ouvertures.
- N'utilisez pas d'aérosols, de solvants, d'alcool ou d'abrasifs.

Service & Assistance

Ne faites pas de réparations vous-même. N'essayez pas d'ouvrir l'appareil ou de le démonter. Vous risquez de vous électrocuter et d'annuler la garantie limitée. Ne contient pas de pièces réparables par l'utilisateur.

Service de garantie

Suivez d'abord les conseils de ce manuel. Si le produit semble endommagé ou ne fonctionne pas correctement, consultez votre revendeur local pour obtenir des instructions sur la façon d'obtenir le service sous garantie.

Recyclage

Ce marquage indique que ce produit ne doit pas être jeté avec les autres déchets ménagers au sein de l'UE. Pour empêcher tout dommage éventuel à l'environnement ou à la santé humaine en raison d'une élimination non contrôlée des déchets, recyclez-le de façon responsable afin de promouvoir la réutilisation durable des ressources matérielles. Pour retourner votre dispositif usagé, veuillez utiliser les systèmes de retour et de collecte ou contacter le vendeur chez qui vous avez acheté le produit. Il pourra s'occuper du recyclage de ce produit en toute sécurité pour l'environnement.

Déclaration de l'UE

Par la présente, Coulisse déclare que l'équipement radio de type CM20 est conforme à la directive 2014/53/UE. Le texte intégral de la déclaration de conformité de l'UE est disponible au lien suivant : www.coulisse.com

1 Téléchargez l'appli et créez un compte

- i** Le pont Wi-Fi MOTION doit être configuré avec l'application MOTION Blinds avant l'installation sur le mur ou le plafond. Téléchargez l'appli MOTION Blinds depuis l'App Store ou Google Play avec votre smartphone ou votre tablette. Ouvrez l'application MOTION et créez un compte.



App Store

Téléchargez l'application MOTION Blinds
rtube.nl/red981



Google Play

Téléchargez l'application MOTION Blinds
rtube.nl/red982



2 Alimentez le pont

- i** Il n'y a pas de chargeur inclus avec ce produit. Tout chargeur USB CC 5 V 1 A universel peut être utilisé pour alimenter le pont MOTION.

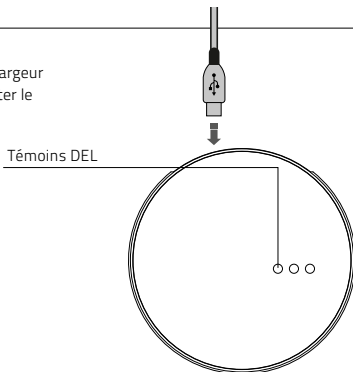
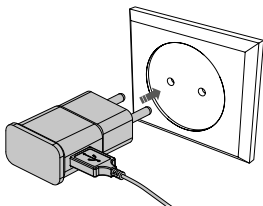

Témoins DEL MOTION

DEL	Couleur	État
Droite	Rouge Fixe	Le pont est allumé
Centre	Violet clignotant	Mode de connexion de pont
Centre	Rouge clignotant	Non connecté au Wi-Fi
Centre	Jaune fixe	Connecté au Wi-Fi, non connecté au cloud MOTION
Centre	Bleu fixe	Connecté au Wi-Fi Connecté au cloud MOTION
Gauche	Violet clignotant	Associer un store à un pont
Gauche Centre	Clignotant vert Bleu fixe	Mise à jour du firmware du pont

3 Connecter le pont à un réseau Wi-Fi

i Une connexion Internet active est nécessaire pour ajouter le pont MOTION à votre réseau Wi-Fi domestique.

Choisissez un emplacement pour le pont MOTION dans votre maison. Connectez votre téléphone intelligent ou votre tablette à votre réseau Wi-Fi domestique pour vérifier la force du signal Wi-Fi à cet emplacement.

Pour éviter toute interférence, assurez-vous que le pont MOTION est situé à au moins un mètre de tout autre appareil Wi-Fi, y compris votre routeur.

Remarque : cet article fonctionne uniquement sur un réseau Wi-Fi 2,4 GHz, et non sur un réseau Wi-Fi 5 GHz. Veuillez consulter le manuel de votre routeur concernant le paramétrage.



Vidéo

Application MOTION:
comment ça fonctionne
rtube.nl/red1074



3G/4G	✗
	✗
	✗
	✓
	✓



- 3.1** Choisissez « Edit (modifier) » en haut à droite de votre écran et ouvrez « Settings (paramètres) ».

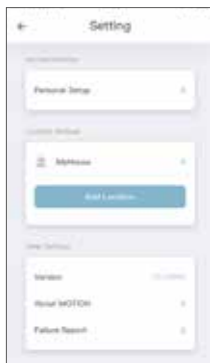

- 3.2** Cliquez sur votre emplacement (MyHouse) pour ajouter le pont MOTION à cet emplacement.



- 3.3** Appuyez sur « Ajouter un pont » et suivez l'assistant d'installation pour configurer votre pont.

L'application MOTION Blinds permet de créer 5 emplacements différents. Jusqu'à 3 ponts peuvent être ajoutés par emplacement.



- 3.4** Vérifiez que le pont MOTION est allumé. Ouvrez les paramètres Wi-Fi de votre appareil mobile et connectez-vous au réseau Wi-Fi avec lequel vous souhaitez connecter le pont MOTION.



- 3.5** Retournez à l'application MOTION Blinds et entrez le mot de passe du réseau Wi-Fi.



- 3.6** Maintenez le bouton « Set » sur le pont MOTION jusqu'à ce que la DEL sur le haut du pont commence à clignoter en violet. Allez à l'application et appuyez sur « Connect ». Maintenant un réseau Wi-Fi MOTION est créé par le pont.



- 3.7 Maintenez l'appli MOTION Blinds en arrière-plan, tout en ouvrant les paramètres Wi-Fi de votre appareil mobile.



- 3.8 Choisissez le réseau MOTION_XXXX pour se connecter au pont. Retournez à l'appli MOTION Blinds pour terminer l'assistant d'installation.



- 3.9 Le pont se connecte automatiquement à votre réseau Wi-Fi. La DEL centrale sur le pont devient d'abord jaune puis bleue. Maintenant, le pont est connecté à votre réseau Wi-Fi et au cloud MOTION.

4 Ajouter un store



4.1 Revenez à l'écran d'accueil de l'appli et ouvrez votre emplacement.

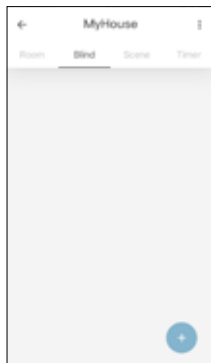

4.2 Accédez à « Blind (store) » et appuyez sur le bouton « + » pour ajouter un nouveau store. (Assurez-vous que votre store a une position haute et basse programmée. Si votre store n'a pas de positions limites, veuillez d'abord les programmer.)

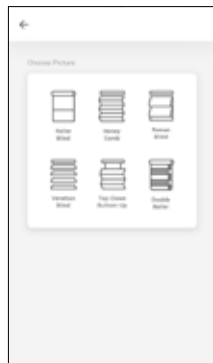

4.3 Choisissez le type de store et suivez l'assistant de configuration.

i Avant d'ajouter un store au pont MOTION, les positions finales du store doivent être programmées avec une télécommande.

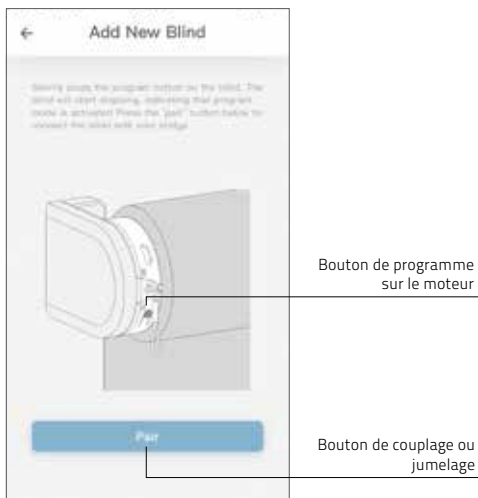

4.4

Appuyez brièvement sur le bouton de programme sur le store. (Consultez le manuel de votre moteur pour voir où se trouve le bouton de programme.) Le store commencera à avancer, indiquant que le mode programme a été activé. Appuyez sur le bouton « pair (jumeler) » pour connecter le store à votre pont.

5 Commande de store à rouleau/nid d'abeilles/romain

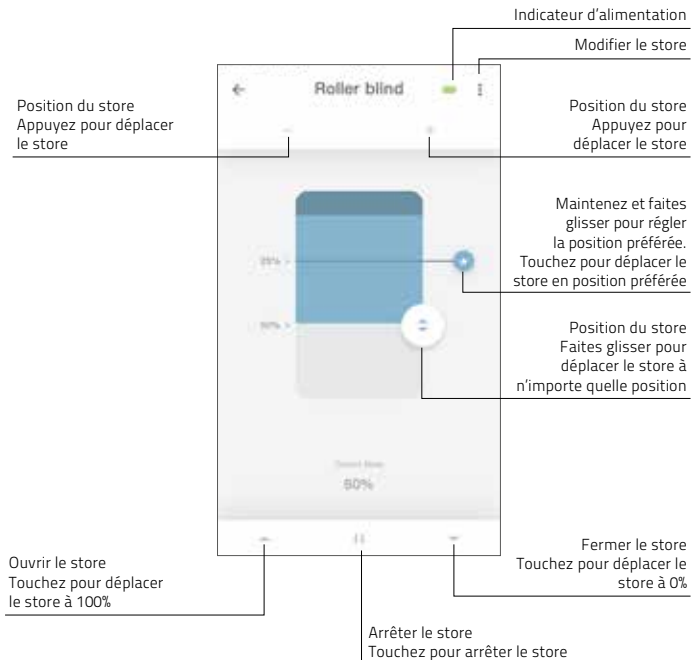

6 Commande à double rouleau

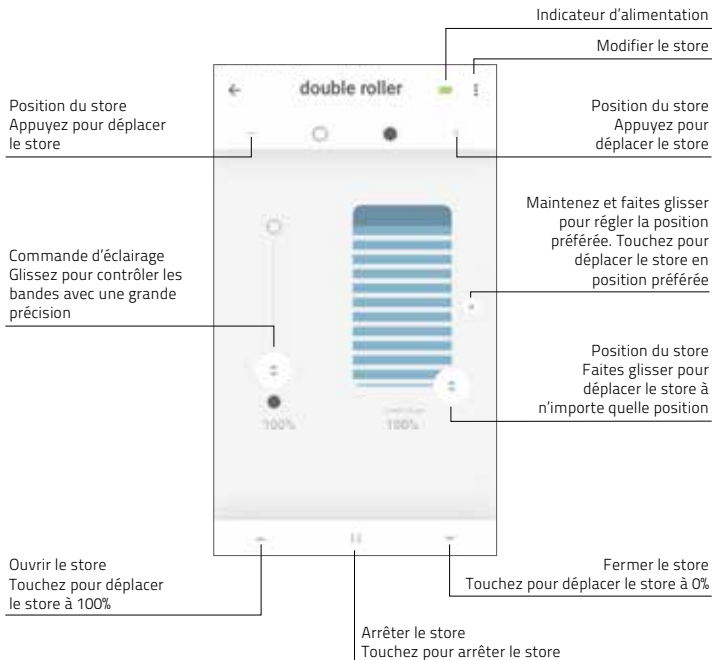

7 Commande de haut en bas/de bas en haut

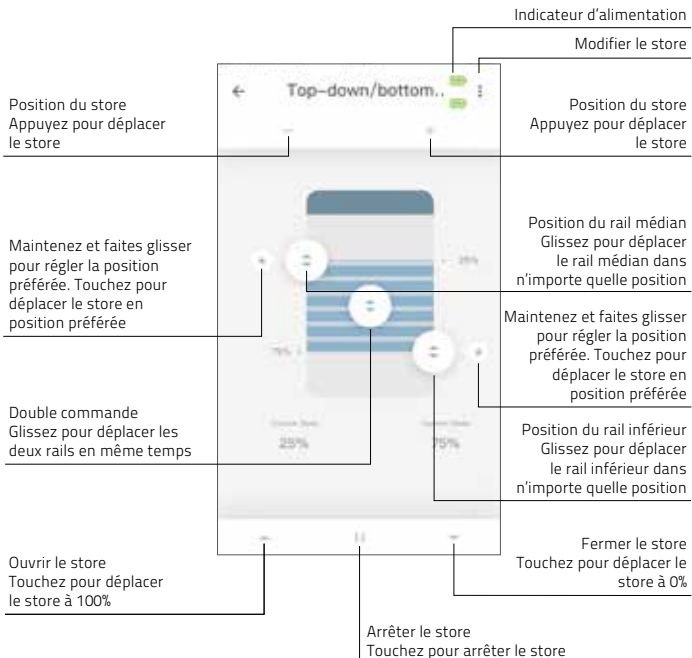

9 Créer une pièce

i Ajoutez des stores à une pièce pour commander les stores individuels ou tous les stores dans une pièce en même temps. Cliquez brièvement sur une pièce pour voir/commander tous les stores dans cette pièce



Ajouter une pièce

9.1 Appuyez sur le bouton « + » pour ajouter une nouvelle pièce.

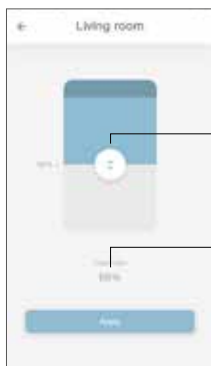

Curseur de positionnement

Position cible

9.2 Cliquez et maintenez le doigt sur une pièce et commandez tous les stores jusqu'à une certaine position.

10 Créer une scène

i Des scènes peuvent être créées pour déplacer vos stores vers des positions prédéfinies.

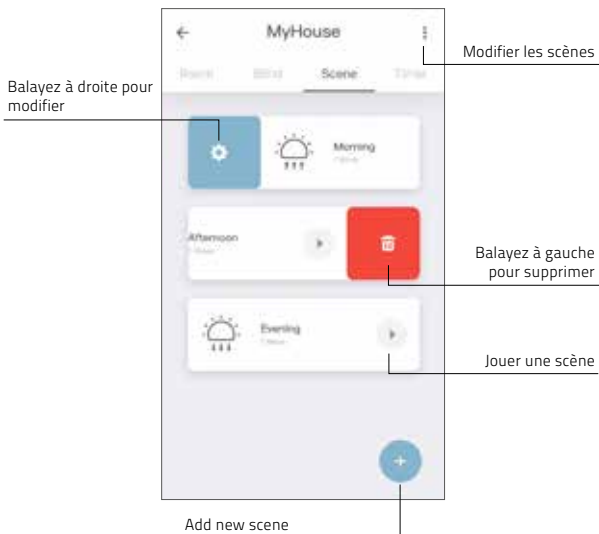

11 Créer une minuterie

i Des minuteries peuvent être créées pour automatiser les stores et les scènes pour que la maison semble habitée.

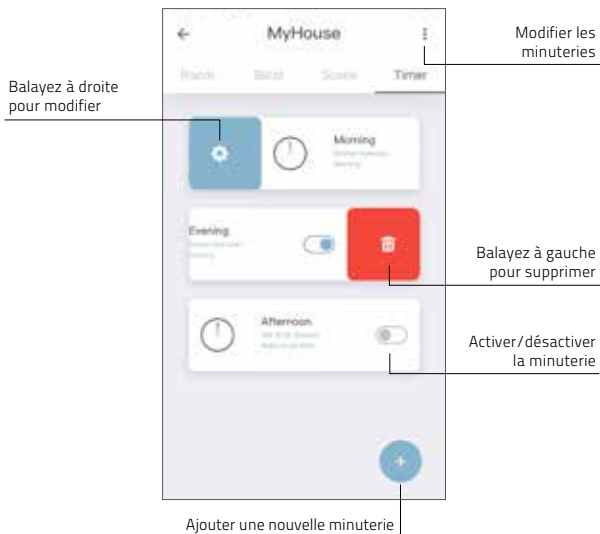

12 Se connecter à une tierce partie

i Le pont MOTION permet de connecter de manière transparente des stores motorisés à des applications domestiques intelligentes. Scannez le code QR ci-dessous pour découvrir les connexions tierces.

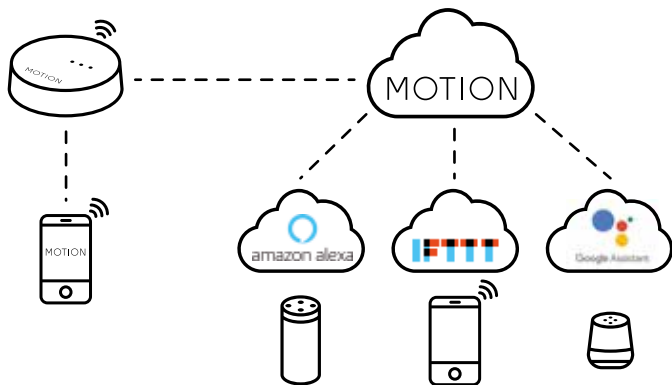

Tierces parties
Découvrez les connexions
tierces pour les stores
MOTION rtube.nl/red1062



13 FAQ

Problème	Cause	Solution
Le store ne répond pas	La batterie du moteur est vide	Chargez le moteur. Consultez le manuel de votre moteur
	Interférences radio/blindage	Assurez-vous que le pont/l'antenne du moteur est hors du chemin d'objets métalliques
	La distance entre le pont et le moteur est trop grande	Rapprochez le pont du store
	Le pont est éteint	Alimentez le pont
Impossible de jumeler votre pont	Mot de passe incorrect	Relancez l'assistant d'installation et utilisez le bon mot de passe. Le mot de passe est sensible à la casse
	Le routeur ne donne pas d'adresse IP au pont	Appuyez sur et maintenez appuyé le bouton reset pendant environ 10 secondes. Le voyant DEL central sera ROUGE. Réessayez d'ajouter le pont
	Bridge tente de se connecter avec 5 GHz.	Veuillez consulter le manuel de votre routeur pour éteindre temporairement votre 5 GHz dans les paramètres du routeur.

Tous droits réservés. Aucune partie de cette publication ne peut être reproduite, stockée dans un système de recherche informatique ou transmise, sous quelque forme ou par quelque moyen que ce soit (électronique, mécanique, par photocopie, enregistrement, numérique ou autre), sans le consentement écrit de l'éditeur.

Bien que ce manuel ait été composé avec le plus grand soin, Coulisse b.v. décline toute responsabilité pour les dommages dus à des erreurs et / ou des défauts dans ce manuel. Coulisse b.v. se réserve le droit de réviser le manuel et de réviser et / ou modifier son contenu à tout moment, sans obligation d'informer toute personne ou entité de telles révisions ou modifications.

MOTION

MANUAL CM-20

Motion Wi-Fi bridge

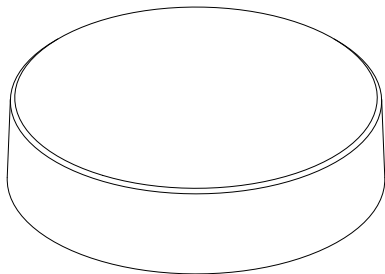

De MOTION Wi-Fi bridge is de basis van je geautomatiseerde rolgordijnennetwerk. De bridge ontsluit talloze mogelijkheden om rolgordijnen met de MOTION app te bedienen. Cloudverbindingen met toonaangevende Smart Home-applicaties maken spraakbesturing en een verscheidenheid aan slimme automatiseringsopties mogelijk.

Max. jaloezieën	Kanalen	Timers	Frequentie	Radio-bereik	Voeding	Lengte	Breedte	Certificaten
30	20	20	433 MHz 2.4 GHz	30 m	USB-C DC 5V 1A	100 mm ø	25 mm	CE FC

In de verpakking vindt u:

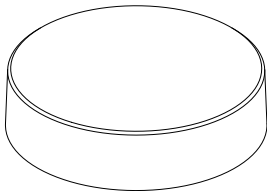

De CM-20 MOTION Wi-Fi bridge

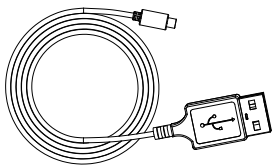

Een USB-C kabel, 75cm



Kijk voor de meest recente informatie en voor bijgewerkte handleidingen op rtube.nl/cm-20

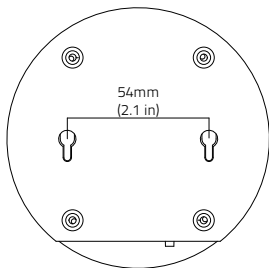
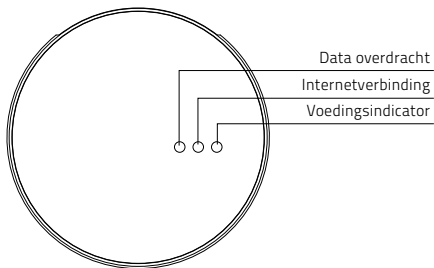
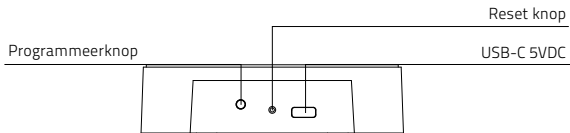

FCC-handleiding | FCC-ID: ZY4CM20

Wettelijk verplichte informatie

1 FCC-informatie voor de gebruiker

Dit product bevat geen onderdelen die door de gebruiker kunnen worden gerepareerd en mag alleen worden gebruikt met goedgekeurde antennes. Wijzigingen of aanpassingen aan het product zorgen dat wettelijke certificeringen en goedkeuringen die van toepassing zijn ongeldig worden.

2 FCC-kennisgevingen inzake elektronische emissies

Dit apparaat voldoet aan deel 15 van de FCC-regels. Op het gebruik zijn de volgende twee voorwaarden van toepassing:

1. Dit apparaat mag geen schadelijke storingen veroorzaken;
2. Dit apparaat moet bestand zijn tegen alle storingen die worden ontvangen, inclusief storingen die een ongewenste werking kunnen veroorzaken.

3 FCC-verklaring inzake storingen door radiofrequentie

Deze apparatuur is getest en voldoet aan de beperkingen voor digitale apparaten van Klasse B, zoals beschreven in deel 15 van de FCC-regels. Deze limieten zijn opgesteld om redelijke bescherming te bieden tegen schadelijke storing wanneer de apparatuur in een bedrijfsomgeving wordt bediend. Deze apparatuur genereert en gebruikt radiofrequentie-energie en kan deze energie uitstralen; als de apparatuur niet wordt geïnstalleerd en gebruikt volgens de instructies, kan deze schadelijke storingen in de radiocommunicatie veroorzaken.

Gebruik van dit apparaat in een woonomgeving kan mogelijk schadelijke storing veroorzaken. In dat geval is de gebruiker verplicht om de storing voor eigen rekening te verhelpen.

Als dit apparaat schadelijke storing aan radiocommunicatie veroorzaakt (wat kan worden vastgesteld door de apparatuur uit en aan te zetten), dan wordt de gebruiker aangemoedigd om de storing te verhelpen door een van de volgende maatregelen uit te voeren:

- Verstel of verplaats de ontvangstantenne;
- Vergroot de afstand tussen de apparatuur en de ontvanger;
- Sluit de apparatuur op een stopcontact aan dat zich in een ander circuit bevindt dan het stopcontact van de ontvanger;
- Raadpleeg de leverancier of een ervaren radio-/tv-monteur voor hulp.

Veiligheid

WAARSCHUWING: Belangrijke veiligheidsinstructies. Volg alle instructies; onjuiste installatie kan tot ernstig letsel leiden.

- Laat kinderen niet met de raambekleding en/of afstandsbediening spelen.
- Zorg dat de raambekleding vrij kan bewegen en niet door objecten wordt geblokkeerd.
- Verf niet over het apparaat.
- Houd het apparaat droog.
- Laat het apparaat niet vallen en stoot en schud er niet mee. Ruwe omgang kan de printplaten beschadigen.
- Dit product is voorzien van een knoopcelbatterij. Het inslikken van een knoopcelbatterij kan binnen twee uur ernstige brandwonden veroorzaken en de dood tot gevolg hebben.
- Houd zowel nieuwe als gebruikte batterijen buiten het bereik van kinderen. Als het batterijvak niet goed sluit, gebruik het product dan niet langer en houd het buiten het bereik van kinderen. Als u vermoedt dat uw kind batterijen heeft ingeslikt of in een lichaamsholte heeft gestopt, schakel dan onmiddellijk een arts in.

Reiniging

Volg deze algemene regels voor het reinigen van de buitenkant en componenten van het apparaat:

- Gebruik een vochtige, zachte, pluisvrije doek. Voorkom dat er vocht in de openingen komt.
- Gebruik geen spuitbussen, oplosmiddelen, alcohol of schuurmiddelen.

Service en ondersteuning

Voer niet zelf reparaties uit. Probeer het apparaat niet te openen of demonteren. U loopt het risico op elektrische schokken. Ook kan de garantie vervallen. Er zijn geen onderdelen waaraan de gebruiker onderhoud kan uitvoeren.

Garantie

Volg eerst het advies in deze handleiding. Ga naar uw lokale dealer voor instructies over hoe u service op grond van de garantie kunt ontvangen als het product defect lijkt of niet goed werkt.

Recycle

Deze markering geeft aan dat dit product in de gehele EU niet mag worden weggegooid met ander huishoudelijk afval. Om mogelijke schade aan het milieu of de menselijke gezondheid door ongecontroleerde afvalverwijdering te voorkomen, dient het op een verantwoorde manier gerecycled te worden om zo het duurzaam hergebruik van materialen te bevorderen. Om uw gebruikte apparaat in te leveren, kunt u gebruikmaken van de teruggave- en inzamelsystemen of contact opnemen met de leverancier van het product. Deze kan ervoor zorgen dat het product op een milieuvriendelijke manier wordt gerecycled.

EU-verklaring

Hierbij verklaart Coulisson dat de radioapparatuur van het type CM20 in overeenstemming is met richtlijn 2014/53/EU. De volledige tekst van de EU-conformiteitsverklaring kan geraadpleegd worden op het volgende internetadres: www.coulisse.com

1 Download de app en creëer een account

- i** De MOTION Wi-Fi bridge moet geïnstalleerd worden met de MOTION Blinds app voor montage aan de muur of het plafond. Download de MOTION Blinds app uit de App Store of Google Play via je smartphone of tablet. Open de MOTION app en creëer een account.



App Store
Download de
MOTION Blinds app
rtube.nl/red981



Google Play
Download de
MOTION Blinds app
rtube.nl/red982



2 De bridge opladen

- i** Er zit geen oplader bij dit product. Elke universele DC 5V 1A USB oplader kan gebruikt worden om de MOTION bridge op te laden.

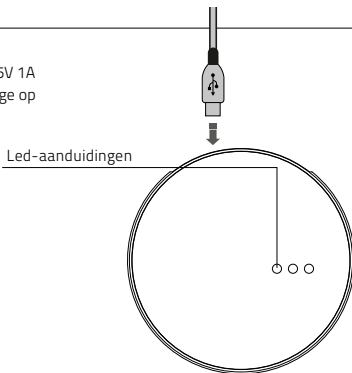
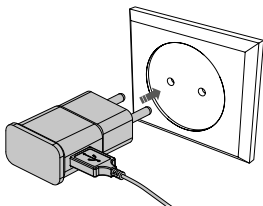

MOTION led-aanduidingen

Ledlampje	Kleur	Status
Rechts	Solid Rood	Bridge verbindingsmodus
Midden	Paars knipperend	Bridge verbindingsmodus
Midden	Rood knipperend	Geen Wi-Fi verbinding
Midden	Solid Geel	Verbonden met Wi-Fi, niet verbonden met de MOTION cloud
Midden	Solid Blauw	Verbonden met Wi-Fi Verbonden met de MOTION cloud
Links	Paars knipperend	Het rolgordijn verbinden met de bridge
Links Midden	Groen knipperend Solid Blauw	Bridge is aan het updaten

3 Verbind de bridge met een Wi-Fi netwerk

i Een werkende internetverbinding is vereist om de MOTION bridge toe te voegen aan je Wi-Fi netwerk. Kies een locatie in je huis voor de MOTION bridge. Verbind je smartphone of tablet met je Wi-Fi netwerk om de sterkte van het signaal op deze locatie te controleren. Zorg ervoor dat de MOTION bridge ten minste één meter van andere draadloze apparaten, inclusief je router, is verwijderd om storing te voorkomen.

Let op: dit product werkt alleen op een 2,4GHZ wifi-netwerk en niet op een 5GHZ wifi-netwerk. Raadpleeg de handleiding van uw router voor de instellingen.



Video
MOTION App:
hoe het werkt
rtube.nl/red1074



3G/4G	✗
	✗
	✗
	✓
	✓



- 3.1 Kies 'Edit' in de rechterbovenhoek van je scherm en open 'Settings'.

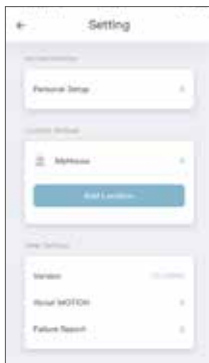

- 3.2 Klik op je locatie (MyHouse) om de MOTION bridge toe te voegen aan deze locatie.



- 3.3 Klik op 'Add Bridge' en volg de stappen in de installatiewizard om de bridge te installeren.

Er kunnen 5 verschillende locaties worden toegevoegd aan de MOTION Blinds app. Per locatie kunnen er 3 bridges worden toegevoegd.



- 3.4** Zorg ervoor dat de MOTION bridge aan staat. Open de Wi-Fi instellingen op je mobiele apparaat en maak verbinding met het Wi-Fi netwerk waarmee je de MOTION bridge wilt verbinden.



- 3.5** Keer terug naar de MOTION Blinds app en voer het wachtwoord van het Wi-Fi netwerk in.



- 3.6** Houd de knop 'Set' op de MOTION bridge ingedrukt tot het ledlampje op de bovenkant van de bridge paars begint te knipperen. Ga naar de app en klik op 'Connect'. Er is nu een MOTION Wi-Fi netwerk gecreëerd door de bridge.



3.7

Laat de MOTION Blinds app op de achtergrond draaien terwijl je de Wi-Fi instellingen van je mobiele apparaat opent.



3.8

Kies het MOTION_XXXX netwerk om verbinding te maken met de bridge. Keer terug naar de MOTION Blinds app om de installatiewizard te voltooien.

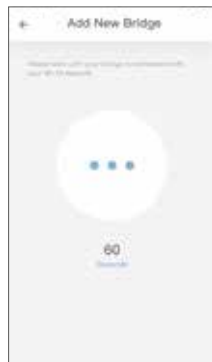

3.9

De bridge maakt automatisch verbinding met je Wi-Fi netwerk. Het middelste ledlampje op de bridge kleurt eerst geel en dan blauw. De bridge is nu verbonden met je Wi-Fi netwerk en de MOTION cloud.

4 Een rolgordijn toevoegen



4.1 Ga terug naar het startscherm van de app en open je locatie.

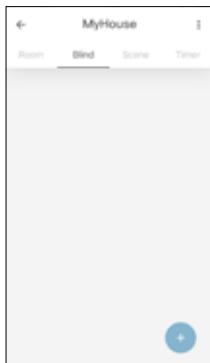

4.2 Navigeer naar 'Blind' en druk op de '+' knop om een nieuw rolgordijn toe te voegen. (Zorg ervoor dat de bovenste en onderste positie van je rolgordijn zijn ingesteld. Als je rolgordijn geen eindposities heeft, installeer deze dan eerst.)

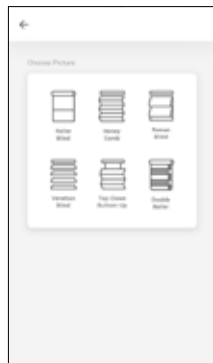

4.3 Kies het type rolgordijn en volg de stappen in de installatiewizard.

i Voordat een rolgordijn aan de MOTION Bridge kan worden toegevoegd, moeten eerst de eindposities van het rolgordijn zijn ingesteld met een afstandsbediening.

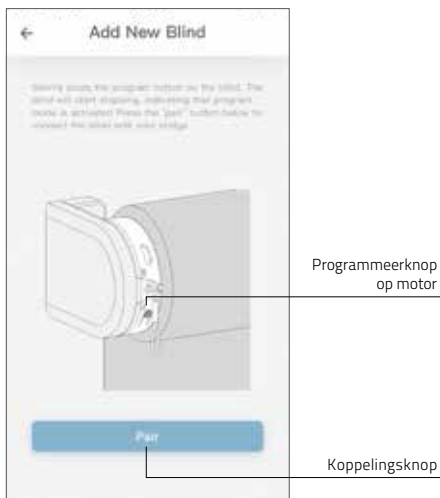

4.4

Druk kort op de programmeerknop op het rolgordijn. (Zie de handleiding van je motor om te zien waar de programmeerknop zit.) Het rolgordijn maakt korte, draaiende bewegingen, dit betekent dat de programmeermodus is geactiveerd. Druk op de 'pair' knop om je rolgordijn met je bridge te verbinden.

5 Rolgordijn / Honeycomb / Vouwgordijn bediening

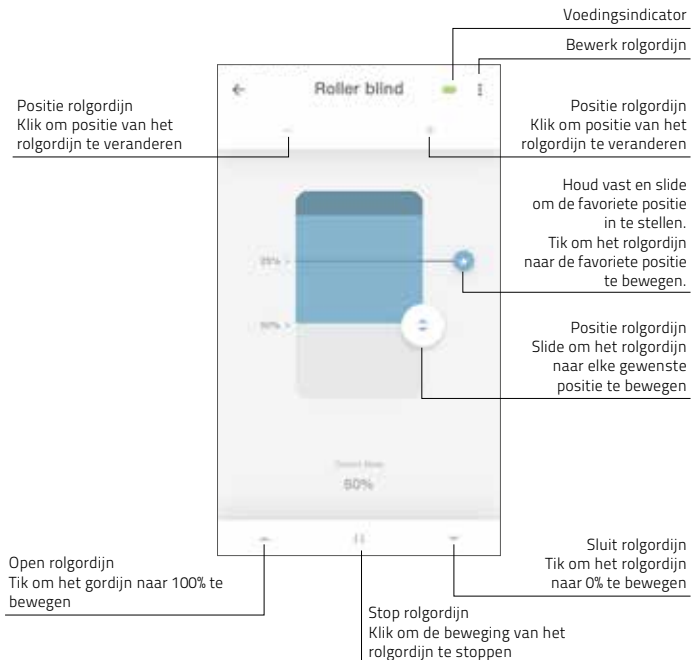

6 Duo-rolgordijn bediening

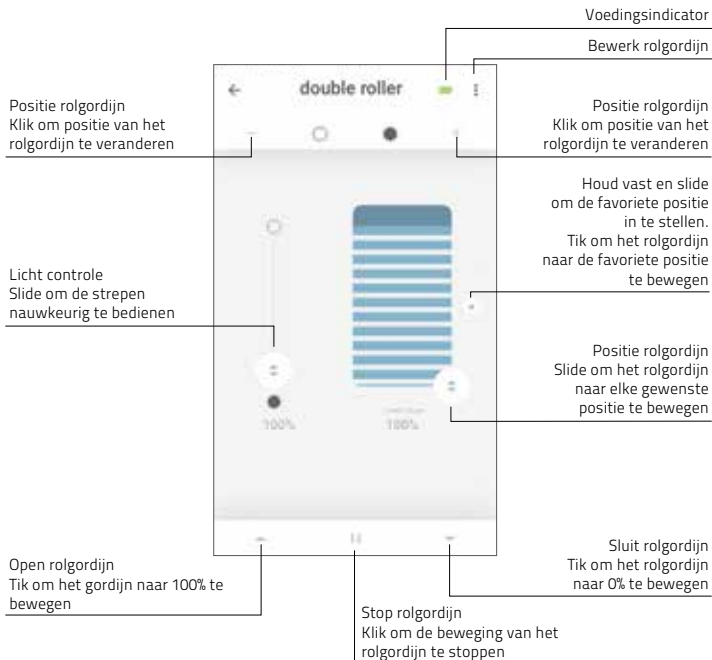

7 Top-down/Bottom-up bediening

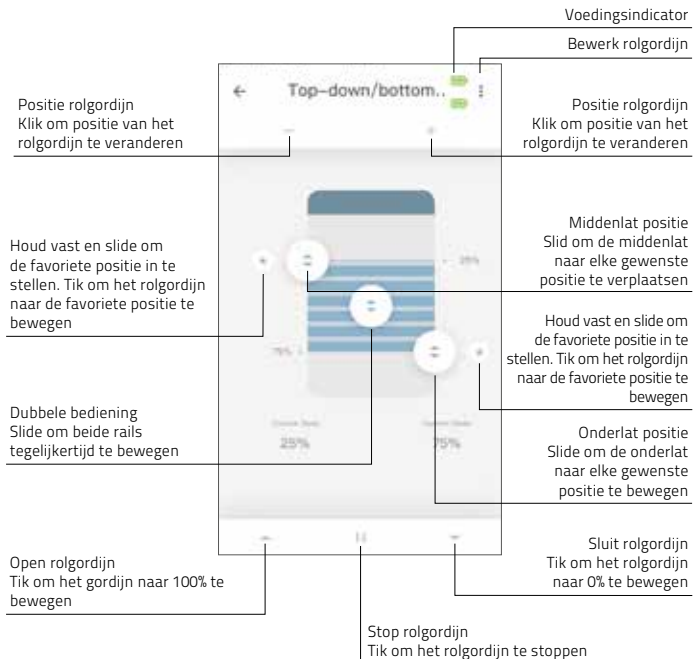

8 Jaloezie bediening

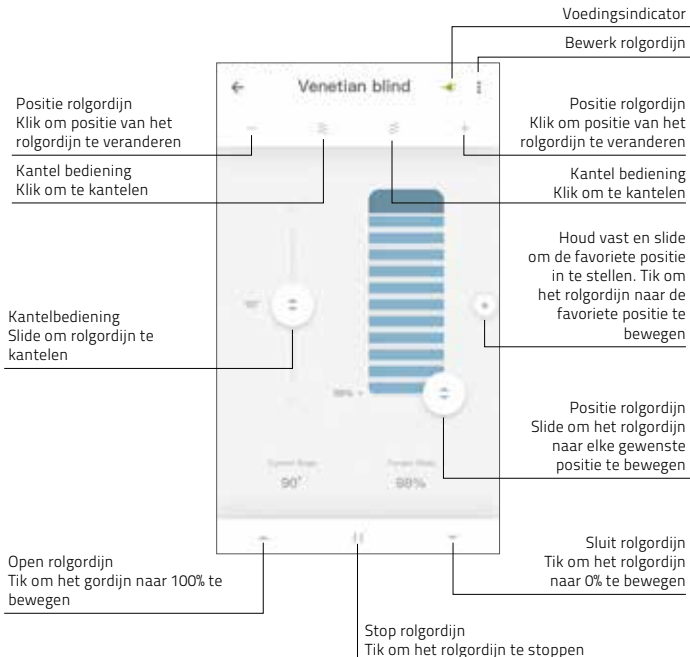

9 Creëer een kamer

i Voeg rolgordijnen aan een kamer toe om de rolgordijnen individueel of allemaal tegelijk te bedienen. Klik kort op een kamer om alle rolgordijnen in deze kamer te bekijken/bedienen.



Voeg kamer toe

9.1 Druk op de '+' knop om een kamer toe te voegen.

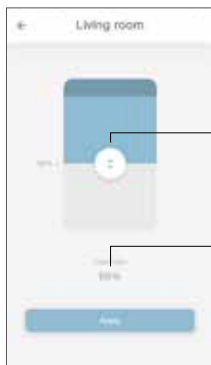

Positie schuif

Doelpositie

9.2 Houd een kamer ingedrukt en bedien alle rolgordijnen naar een bepaalde positie.

10 Creëer een scène

i Scènes kunnen worden gecreëerd om rolgordijnen naar vooraf ingestelde posities te verplaatsen.

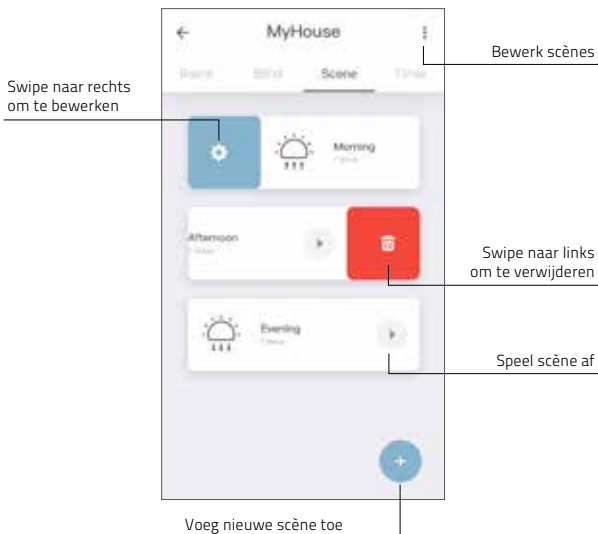

11 Creëer een timer

i Timers can be created to automate blinds and scenes to make the home seem inhabited.

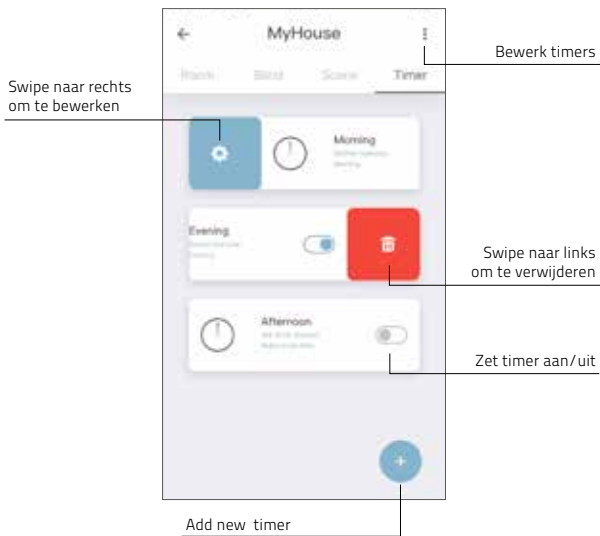

12 Verbind met een derde partij

- i** Met de MOTION bridge kunnen gemotoriseerde rolgordijnen naadloos worden aangesloten op Smart Home-applicaties. Scan onderstaande QR-code om mogelijke verbindingen met een derde partij te ontdekken.

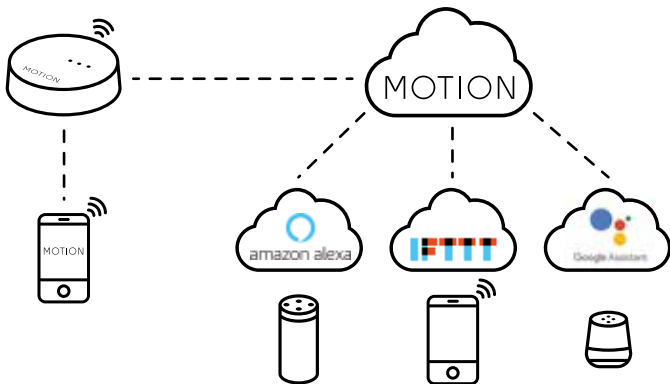

Derde partij

Ontdek verbindingsmogelijkheden van MOTION met een derde partij [rtube.nl/red1062](https://www.youtube.com/watch?v=red1062)



13 Veelgestelde vragen

Probleem	Oorzaak	Oplossing
Het rolgordijn reageert niet	De batterij van de motor is leeg	Laad de motor op. Zie de handleiding van de motor
	RF-storing	Zorg ervoor dat de bridge/antenne van de motor niet in de buurt staat van metalen voorwerpen
	De afstand tussen de bridge en de motor is te groot	Plaats de bridge dichterbij het rolgordijn
	De bridge staat uit	Zet de bridge aan
Can not pair your bridge	Onjuist wachtwoord	Start de installatiewizard opnieuw op en gebruik het juiste wachtwoord. Het wachtwoord is hoofdlettergevoelig
	De router geeft geen IP-adres aan de bridge	Houd de resetknop 10 seconden ingedrukt. Het middelste ledlampje wordt rood. Probeer de bridge opnieuw toe te voegen
	Bridge probeert te verbinden met 5GHz.	Raadpleeg de handleiding van uw router om het 5GHZ-netwerk tijdelijk uit te schakelen in de instellingen van uw router.

Alle rechten voorbehouden. Niets uit deze publicatie mag in enige vorm of op enige wijze (elektronisch, mechanisch, door fotokopieën, opnamen, digitaal of anderszins) worden vervoelvoudigd, opgeslagen in een geautomatiseerd gegevensbestand of verzonden zonder schriftelijke toestemming van de uitgever.

Deze handleiding is met uiterste zorg opgesteld, maar Coulisse b.v. aanvaardt geen aansprakelijkheid voor schade als gevolg van vergissingen en/of fouten in deze handleiding.

Coulisse b.v. behoudt zich het recht voor om de handleiding op elk gewenst moment te herzien en om inhoud te herzien en/of te wijzigen. Coulisse b.v. is niet verplicht om enige persoon of entiteit te informeren over dergelijke herzieningen of wijzigingen.

MOTION

MANUAL CM-20

MOTION Puente wifi

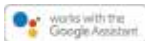
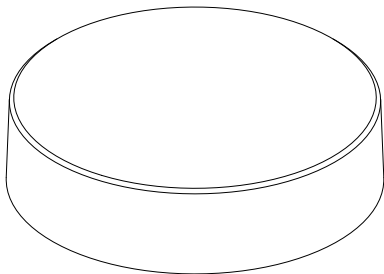

El puente wifi MOTION es el centro de la red de persianas automatizadas de su casa. El puente abre un sinfín de posibilidades para controlar persianas con la aplicación MOTION. Las conexiones en la nube en combinación con las mejores apps para hogares inteligentes permiten el control por voz y una gran variedad de opciones de automatización inteligente.

Máx. de persianas	Escenas	Temporizadores	Frecuencia	Alcance	Alimenta- ción	Largo	Alto	Certificados
30	20	20	433 MHz 2.4 GHz	30 m	USB-C DC 5V 1A	100 mm ø	25 mm	CE FC

Esta caja incluye los siguientes elementos:

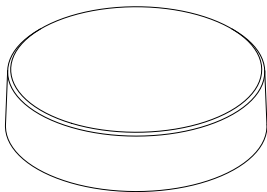

Puente wifi MOTION CM-20i

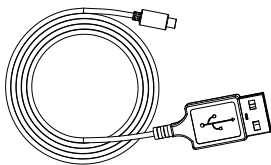

Cable USB-C 75 cm



Para la información más reciente y los manuales actualizados, visite rtube.nl/cm-20

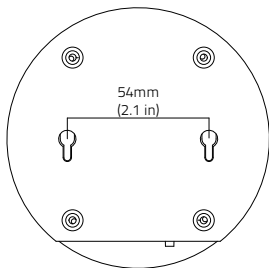
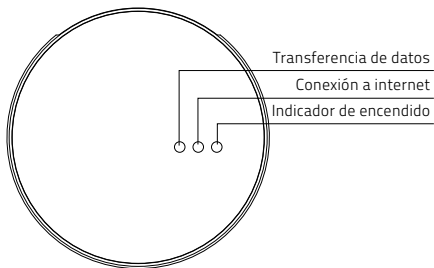
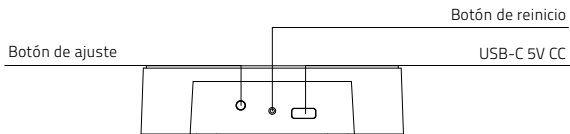

Manual de la FCC | FCC: ZY4CM20

Información reglamentaria

1 Información de la FCC para el usuario

Este producto no contiene ninguna pieza que el usuario pueda reparar o reemplazar, y solo debe utilizarse con antenas aprobadas. Cualquier cambio o modificación al producto invalidará todas las certificaciones y aprobaciones reglamentarias aplicables.

2 Avisos de emisión electrónica de la FCC

Este dispositivo cumple con el apartado 15 de las Normas de la FCC. El funcionamiento está sujeto a las dos condiciones siguientes:

1. Este dispositivo no puede causar interferencias perjudiciales.
2. Este dispositivo debe aceptar cualquier interferencia que reciba, incluida aquella que pueda causar un funcionamiento no deseado del dispositivo.

3 Declaración de interferencia de radiofrecuencia de la FCC

Este equipo ha sido sometido a las pruebas pertinentes y cumple con los límites establecidos para un dispositivo digital de clase B, conforme al apartado 15 de las Normas de la FCC. Estos límites están diseñados para proporcionar una protección razonable contra interferencias perjudiciales, cuando el equipo funciona en un entorno comercial. Este equipo genera, utiliza y puede irradiar energía de radiofrecuencia y, si no se instala y utiliza confor-

me a las instrucciones, puede causar interferencias perjudiciales en las comunicaciones de radio. El funcionamiento de este equipo en un área residencial puede causar interferencias perjudiciales, en cuyo caso el usuario tendrá que corregir la interferencia a su propio coste. Si este equipo ocasiona interferencias perjudiciales en la recepción de la televisión o radio, lo cual puede determinarse encendiendo y apagando el equipo, se recomienda al usuario que intente corregir la interferencia, adoptando una o más de las siguientes medidas:

- Reorientar o reubicar la antena de recepción
- Aumentar la separación entre el equipo y el receptor
- Conectar el equipo a una salida en un circuito diferente al utilizado para la conexión del receptor
- Consultar al distribuidor o a un técnico de radio/TV experimentado para obtener ayuda

Seguridad

ADVERTENCIA: Instrucciones de seguridad importantes. Siga todas las instrucciones. Una instalación incorrecta puede provocar lesiones graves.

- No permita que los niños jueguen con la persiana y/o el mando a distancia.
- Asegúrese de que la persiana pueda moverse libremente y no esté obstruida por objetos.
- No pinte el dispositivo.
- Mantenga el dispositivo seco.
- No golpee, agite o deje caer el dispositivo. El manejo brusco puede dañar los circuitos internos.
- Este producto contiene una pila de botón. Si la pila de botón se ingiere, puede causar quemaduras internas graves en tan solo 2 horas y puede provocar la muerte.
- Mantenga las pilas nuevas y usadas fuera del alcance de los niños. Si el compartimento de las pilas no cierra correctamente, deje de utilizar el producto y manténgalo fuera del alcance de los niños. Si cree que las pilas fueron ingeridas o se encuentran dentro del cuerpo, busque atención médica inmediata.

Limpieza

Siga estas reglas generales al limpiar la parte exterior del dispositivo y sus componentes:

- Usar un paño húmedo, suave y sin pelusa. Evitar la entrada de humedad en las aberturas.
- No usar aerosoles, disolventes, alcohol o abrasivos.

Servicio y soporte

No realice reparaciones por su cuenta. No intente abrir o desensamblar el dispositivo. Corre el riesgo de una descarga eléctrica y de invalidar la garantía limitada. No hay ninguna pieza en el interior servible para el usuario.

Servicio de garantía

Para empezar, siga los consejos de este manual. Si el producto parece estar dañado o no funciona adecuadamente, diríjase a su distribuidor local para recibir instrucciones sobre cómo usar la garantía.

Reciclaje

Esta marca indica que este producto no debe desecharse con otros residuos domésticos en toda la UE. Para evitar posibles daños al medio ambiente o a la salud, con la eliminación incontrolada de residuos, se debe reciclar correctamente para promover la reutilización sostenible de los recursos materiales. Para devolver el dispositivo usado, utilice los sistemas de devolución y recogida establecidos o póngase en contacto con el establecimiento donde adquirió el producto. Ellos pueden recoger este producto para un reciclado seguro y no contaminante.

Declaración de la UE

Por la presente, Coulisse declara que el tipo de equipo de radio CM20 cumple la Directiva 2014/53/UE. El texto completo de la declaración de conformidad de la UE está disponible en la siguiente dirección de internet: www.my.coulisse.com

1 Descargar la app y crear una cuenta

- i** El puente wifi MOTION debe configurarse con la aplicación MOTION Blinds antes de ser instalado en la pared o en el techo. Descargue la aplicación MOTION Blinds en su smartphone o tablet desde Google Play o desde la App Store. Abra la app y cree una cuenta.



App Store
Descargue la
MOTION Blinds app
rtube.nl/red981



Google Play
Descargue la
MOTION Blinds app
rtube.nl/red982



2 Alimentar el puente

i Este producto se suministra sin cargador. Cualquier cargador USB CC 5V 1A universal puede ser utilizado para alimentar el puente MOTION.

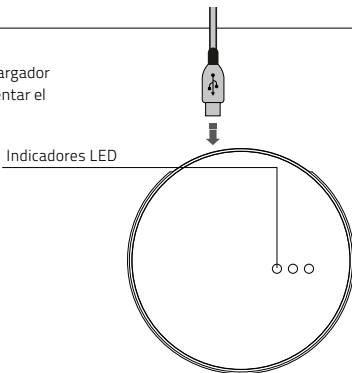
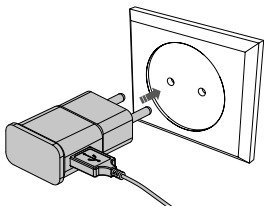

Indicadores LED MOTION

LED	Color	Estado
Derecha	Rojo fijo	El puente está encendido
Centro	Morado intermitente	Modo de conexión del puente
Centro	Rojo intermitente	No conectado a la red wifi
Centro	Amarillo fijo	Conectado a la red wifi, no conectado a MOTION cloud
Centro	Azul sólido	Conectado a la red Wi-Fi Conectado a MOTION cloud
Izquierda	Morado intermitente	La persiana se está emparejando con el puente
Izquierda Centro	Verde parpadeante Azul fijo	Actualización de firmware

3 Conectar el puente a la red wifi

i Es necesario disponer de una conexión activa a internet para añadir el puente MOTION a su red wifi doméstica.

Elija una ubicación para el puente en su casa. Conecte su smartphone o tablet a la red wifi doméstica y compruebe la fuerza de la señal en esa ubicación.

Para evitar interferencias, asegúrese de que el puente MOTION esté ubicado a una distancia mínima de un metro de otros dispositivos de conexión wifi, incluyendo el router.

Nota: este elemento solo funciona en una red Wifi de 2,4 GHz, no en una red Wifi de 5 GHz. Consulte los ajustes de configuración en el manual de su rúter.



Vídeo
Aplicación MOTION:
cómo funciona
rtube.nl/red1074



3G/4G	✗
	✗
	✗
	✓
	✓



- 3.1** Seleccione « Editar » en la parte superior derecha de la pantalla y abra « Ajustes ».

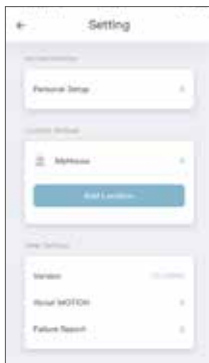

- 3.2** Haga clic en su ubicación (MyHouse) para añadir el puente MOTION a esta ubicación.



- 3.3** Pulse «Añadir puente» y siga el asistente de instalación para configurar el puente.

La aplicación MOTION Blinds permite crear 5 ubicaciones diferentes. Es posible añadir hasta 3 puentes a cada ubicación.



- 3.4** Asegúrese de que el puente MOTION esté encendido. Abra la configuración wifi de su dispositivo móvil y conéctese a la red wifi a la que desea conectar el puente MOTION.



- 3.5** Vuelva a la aplicación MOTION Blinds e introduzca la contraseña de la red wifi.



- 3.6** Pulse y mantenga pulsado el botón de ajuste en el puente MOTION hasta que la LED en la parte superior del puente empiece a parpadear en morado. Vaya a la aplicación y pulse « Conectar » . Ahora el puente ha creado una red wifi MOTION.



- 3.7** Deje la aplicación MOTION Blinds ejecutándose en segundo plano mientras que abre los ajustes de la configuración wifi en su dispositivo móvil.



- 3.8** Seleccione la red MOTION_XXXX para conectar con el puente. Vuelva a la aplicación MOTION Blinds para terminar el asistente de instalación.

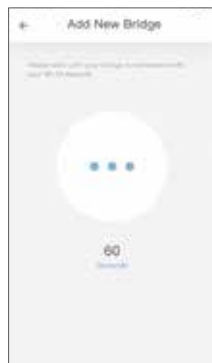

- 3.9** El puente se conectará automáticamente a la red wifi. En el puente, la luz LED del centro se pondrá primero amarillo y luego azul. Ahora, el puente está conectado a su red wifi y a MOTION cloud.

4 Añadir una persiana



4.1 Vuelva a la pantalla de inicio de la aplicación para abrir su ubicación.

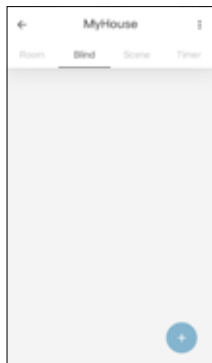

4.2 Desplácese a «Persiana» y pulse el botón «+» para añadir una persiana nueva. (Asegúrese de que la persiana tenga una posición superior e inferior programada. Si la persiana todavía no tiene posiciones finales, éstas se deben programar primero.)

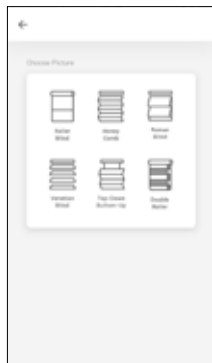

4.3 Seleccione el tipo de persiana y siga el asistente de configuración.

i Antes de añadir una persiana al puente MOTION, las posiciones finales de la persiana deben ser programadas con un control remoto.

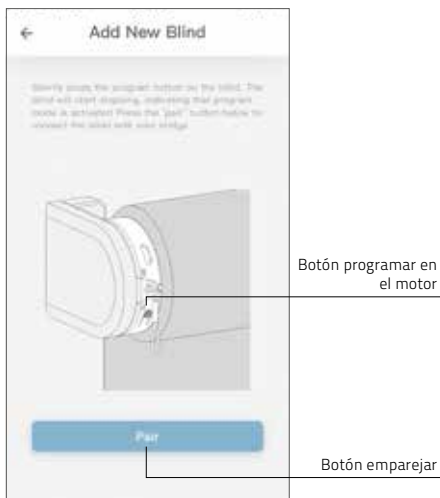

4.4

Pulse brevemente el botón programar del motor. (Consulte el manual del motor para saber dónde se encuentra dicho botón.) La persiana se moverá para indicar que el modo de programación ha sido activado. Pulse el botón « emparejar » para conectar la persiana con el puente.

5 Control de estores enrollables / nido de abeja / plegables

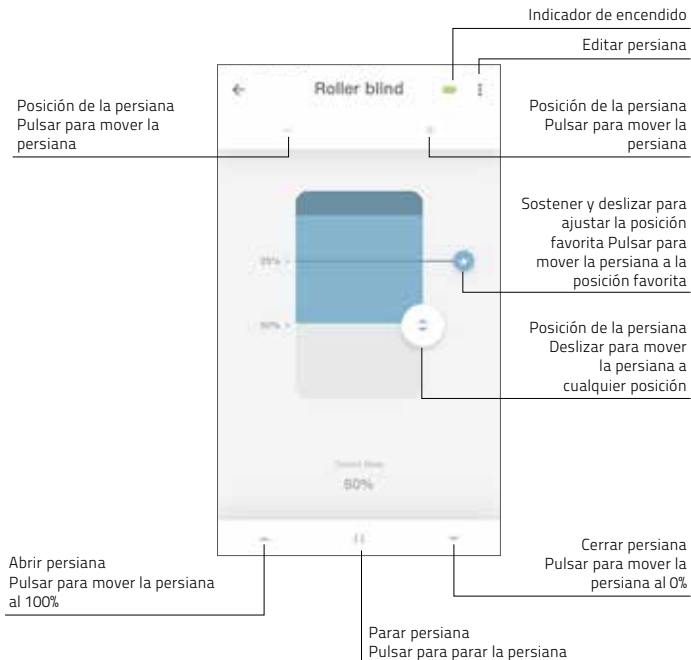

7 Control de sistema arriba-abajo/abajo-arriba

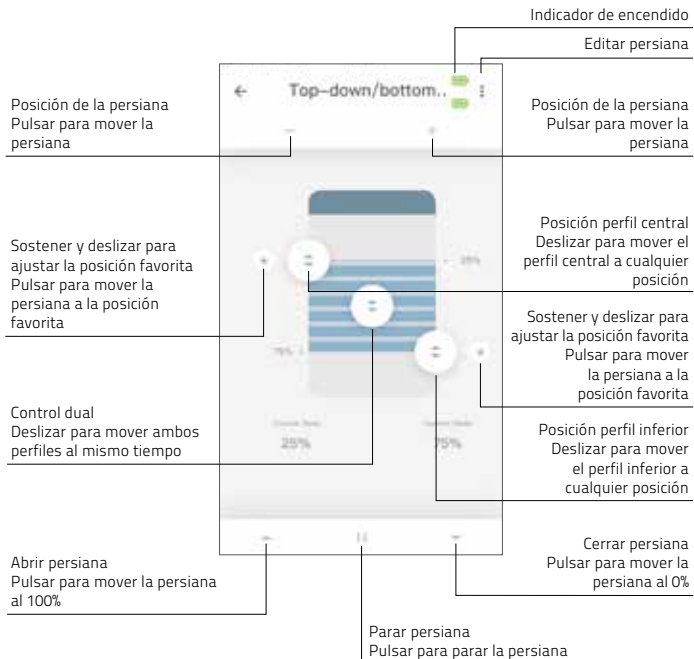

9 Crear una estancia

i Añada persianas a una estancia para controlar las persianas de modo individual o todas al mismo tiempo. Haga brevemente clic en una estancia para ver o controlar todas las persianas de dicha estancia.



Añadir estancia

9.1 Pulse el botón «+» para añadir una nueva estancia.

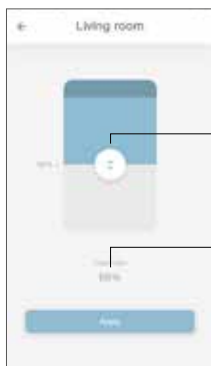

Control deslizante de posición

Posición de destino

9.2 Haga clic y sostenga una estancia para mover todas las persianas a una posición determinada.

10 Crear una escena

i Es posible crear escenas para mover las persianas a posiciones preestablecidas.

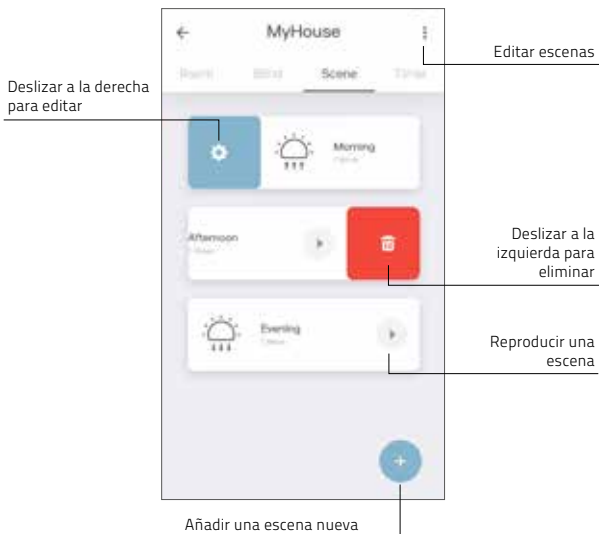

11 Crear un temporizador

i Es posible crear temporizadores para automatizar las persianas y escenas para que la casa parezca habitada.

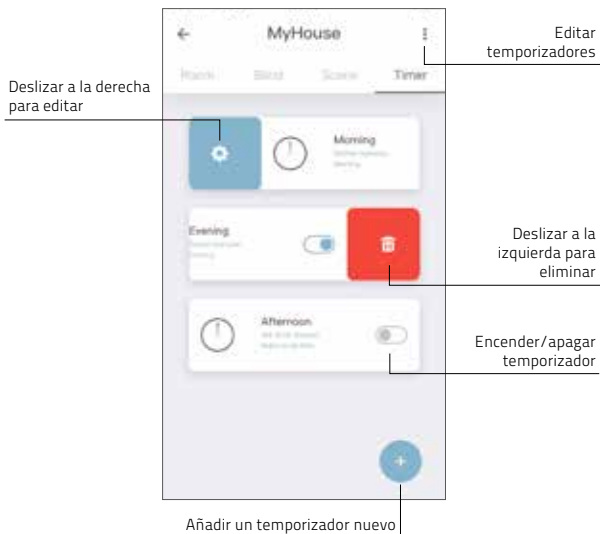

12 Conectar con terceros

i El puente MOTION permite conectar sin problemas las persianas motorizadas a aplicaciones de hogares inteligentes. Escanee el código QR mostrado a continuación para descubrir las conexiones con terceros.

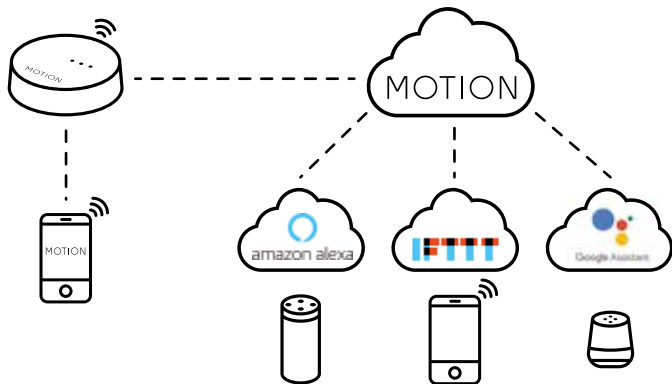

Terceros

Descubra conexiones
con terceros para
MOTION Blinds
rtube.nl/red1062



13 Preguntas frecuentes

Problema	Causa	Solución
La persiana no responde	La batería del motor está vacía	Cargue el motor. Consulte el manual del motor
	Interferencias de radio / protección	Compruebe que el puente / la antena del motor esté fuera del alcance de objetos metálicos
	La distancia entre el puente y el motor es demasiado grande	Acerque el puente a la persiana
	El puente está apagado	Encienda el puente
No se puede emparejar el puente	Contraseña incorrecta	Reinicie el asistente de configuración e introduzca la contraseña correcta. La contraseña es sensible a mayúsculas
	El router no asigna una dirección IP al puente	Pulse y sostenga el botón de reinicio durante 10 segundos. La luz LED del centro se volverá ROJA. Vuelva a añadir el puente
	El puente está intentando conectarse a 5 GHz.	Consulte el manual de su router para apagar temporalmente su conexión de 5 GHz en la configuración de su router.

Todos los derechos reservados. Ninguna parte de esta publicación puede ser reproducida, guardada en cualquier sistema recuperable, o transmitida de cualquier forma, ya sea por medios electrónicos, mecánicos, fotocopiados, grabados, digitales o cualquier otro sin el consentimiento por escrito del editor. A pesar de que este manual se ha preparado con el máximo cuidado, Coulisse B.V. no aceptará ninguna responsabilidad por daños debido a errores y/o defectos en este manual.

Coulisse B.V. se reserva el derecho de revisar el manual y revisar y/o cambiar el contenido en cualquier momento, sin la obligación de notificar a ninguna persona o entidad de tales revisiones o cambios. La versión más reciente reemplaza las versiones anteriores de este manual.

